



Main Catalog

Dental



Competence in Instruments
MADE IN GERMANY

Bone-Fixation-Set

Σετ μικροβιδών για τη στερέωση των τεμαχίων οστικών μοσχευμάτων στην περιοχή όπου τοποθετούνται.



Περιλαμβάνει:

- 1 κουτί τοποθέτησης των περιεχομένων
- 1 κατσαβίδι
- 1 άκρο για το κατσαβίδι, που εισχωρεί στην εσοχή της κεφαλής της βίδας
- 1 τρύπανο και 10 ίδιες βίδες της επιλογής του γιατρού

ΓΕΩΜΕΤΡΙΑ ΤΩΝ ΜΙΚΡΟΒΙΔΩΝ

- Ακρίβεια κατασκευής, κεφαλή με σταυρωτή εσοχή
- Πατενταρισμένο, αυτο-εφαρμοζόμενο άκρο κατσαβιδιού
- Γρήγορη κι εύκολη μεταφορά των αυτο-συγκρατούμενων βιδών
- Υψηλή τριβή μεταξύ του άκρου του κατσαβιδιού και της κεφαλής της βίδας

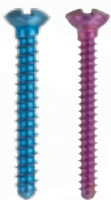

ΜΙΚΡΟΒΙΔΕΣ ΤΙΤΑΝΙΟΥ

Διάμετροι: 1,2 mm/1,4 mm
Μήκη: 6, 8, 11, 13 mm



ΜΙΚΡΟΒΙΔΕΣ ΑΠΟ ΚΡΑΜΑ ΑΤΣΑΛΙΟΥ (IMPLANT STEEL ALLOY)

Διάμετρος: 1,0 mm
Μήκη: 8, 11, 13 mm

- Ιδανικές για πολύ μικρά τεμάχια οστού και για 3D αύξηση
- Το ειδικό κράμα ατσάλιου εμποδίζει την οστεοενσωμάτωση κι επομένως μειώνει τον κίνδυνο θραύσης κατά την αφαίρεση της βίδας



Vitsaropoulos
COMPLETE DENTAL SOLUTIONS

USTOMED®
INSTRUMENTE

02	SCALPELS AND PERIOTOMES	σελ.	5-7
03	SCISSORS	σελ.	8-14
04	TC SCISSORS	σελ.	15-16
05	MICRO SCISSORS	σελ.	17-18
08	DISSECTING AND TISSUE FORCEPS	σελ.	19-23
09	MICRO AND ATRAUMATIC FORCEPS	σελ.	24-27
10	COLLEGE FORCEPS AND MEASURING INSTRUMENTS	σελ.	28-33
13	HEMOSTATIC FORCEPS	σελ.	34-37
19	NEEDLE HOLDER	σελ.	38-39
20	TC NEEDLE HOLDER	σελ.	40-49
24	RETRACTORS	σελ.	50-62
27	ELEVATORS AND RASPATORIES	σελ.	63-69

31	BONE RONGEURS	σελ.	70-72
42	MEASURING DEVICES	σελ.	73-74
46	SINUS CURETTES	σελ.	75-78
67	BONE PREP INSTRUMENTS AND TOOLS	σελ.	79-90
68	HARD AND SOFT TISSUE AUGMENTATION SCREWS AND PINS	σελ.	91-97
79	CLEANING AND CARE	σελ.	98
80	EXTRACTING FORCEPS ENGLISH PATTERN	σελ.	99-114
84	MOUTH MIRRORS	σελ.	115-117
85	PERIODONTICS	σελ.	118-125
90	STORAGE, ORGANISATION AND STERILIZATION	σελ.	126-128
91	INSTRUMENT SETS	σελ.	129-135

02

SCALPELS AND PERIOTOMES



02

Standard Scalpels and Blades

Blades, sterile, 100pcs.



02-040-011
Size



02-040-012
Size 12



02-040-015
Size 15



02-040-124
Size 12D



02-040-153
Size 15C



1/1



1/1



1/1



02-030-030

Scalpel Handle,
No. 3
125mm

02-030-070

Scalpel Handle,
No. 7

02-030-150 G

Scalpel Handle, 15
cm, round shaped,
smooth

02-046-022

BLADE BUTLER, for
removing scalpel
blades from handle

Micro Blades, sterile, 25pcs.



02-044-063
Size 63



02-044-067
Size 67



02-044-069
Size 69



1/1

02-038-140

Micro-Scalpel Handle, 14 cm,
anatomical shape



1/1

02-795-000POT3

Periotome, size 1, straight,
complete, peek handle



1/1

02-796-000POT3

Periotome, size 1, straight,
complete, peek handle

03

SCISSORS



REYNOLDS



03-155-145

14.5cm, delicate, curved

METZENBAUM



03-071-145

14.5cm, curved

JAMESON



03-185-155

15.5cm, delicate, curved

KILNER



03-449-120

12cm, delicate, curved



03-081-145

14.5cm, delicate, curved





03-081-145 SC

14.5cm, delicate, curved, Super-Cut

03

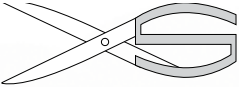
Suture & Gum Scissors

 <p>STANDARD: Standard Cut</p>	 <p>SUPERCUT (SC): Special Cut with tothing in one scissor blade in order to prevent sliding of gum and suture material</p>
--	---

S You can find the TC Version of this Scissor in Chapter 04!



1/1

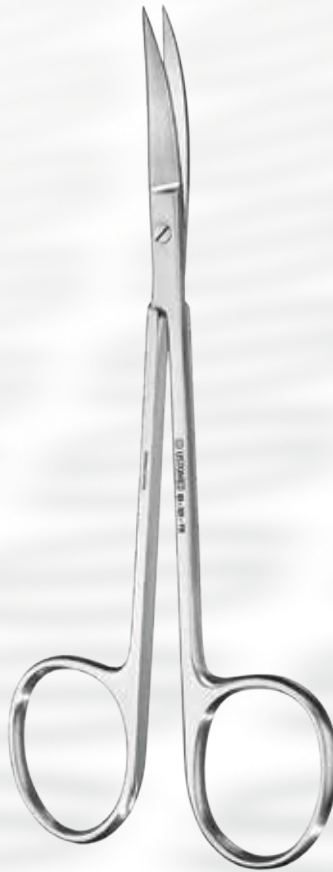

1/1



1/1

<p>11.5cm, straight</p> <p>03-320-115 Standard</p> <p>03-320-115 SC Super-Cut</p> <p>03-316-115 Standard, large ring</p>	<p>11.5cm, curved</p> <p>03-321-115 Standard</p> <p>03-321-115 SC Super-Cut</p> <p>03-317-115 Standard, large ring</p>	<p>13cm, X-tra large ring</p> <p>03-327-130 curved</p> <p>03-327-130 SC curved, Super-Cut</p> <p>03-326-130 straight</p>
---	---	---

JOSEPH



14cm,
03-440-140
Standard
03-440-140 SC
Super-Cut



14cm, curved
03-441-140
Standard
03-441-140 SC
Super-Cut

KELLY



curved, Standard
03-631-160
16cm
03-631-180
18cm





straight, Standard
03-630-160
16cm
03-630-180
18cm



curved, Super-Cut
03-631-160 SC
16cm
03-631-180 SC
18cm

03

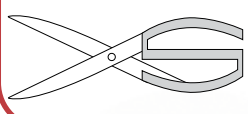
Suture & Gum Scissors

 <p>STANDARD: Standard Cut</p>	 <p>SUPERCUT (SC): Special Cut with tothing in one scissor blade in order to prevent sliding of gum and suture material</p>
--	---

FOX



03-421-130
13cm, curved plain



03-420-130
13cm, straight



03-417-130 SC
13cm, curved, Super-Cut

LA GRANGE



03-401-105
10.5cm Standard
03-401-105 SC
Super-Cut

LOCKLIN

Gum Scissors

03-635-160

16cm, serrated



SPENCER



1/1

Ligature Scissors

03-720-130

13cm



1/1

03-325-115

11.5cm, angled



1/1

03-351-115

11.5cm, very fine tips

03

Special Scissors

SURGICAL SCISSORS



3/4

03-027-145

14.5cm, curved

1/1

sharp/blunt tips

03-022-145
straight, 14.5cm

03-022-175
straight, 17.5cm

BEEBEE



1/1

03-744-105

Wire-Cutting Scissors,
10.5cm, straight, sharp

LISTER



1/1

03-781-145

Bandage Scissors, 14.5cm

UNIVERSAL



1/1

03-745-105

Wire-Cutting Scissors,
10.5cm, curved, sharp



1/2

03-805-180

Universal Bandage Scissors,
18cm

04

TC SCISSORS



04

TC Suture & Gum Scissors



TUNGSTEN CARBIDE (TC):

Special Hard-Metal Inlays increasing life time and sharpness, of the Instrument

FOX

JOSEPH



04-417-130
13cm, curved,



04-441-140
14cm, curved

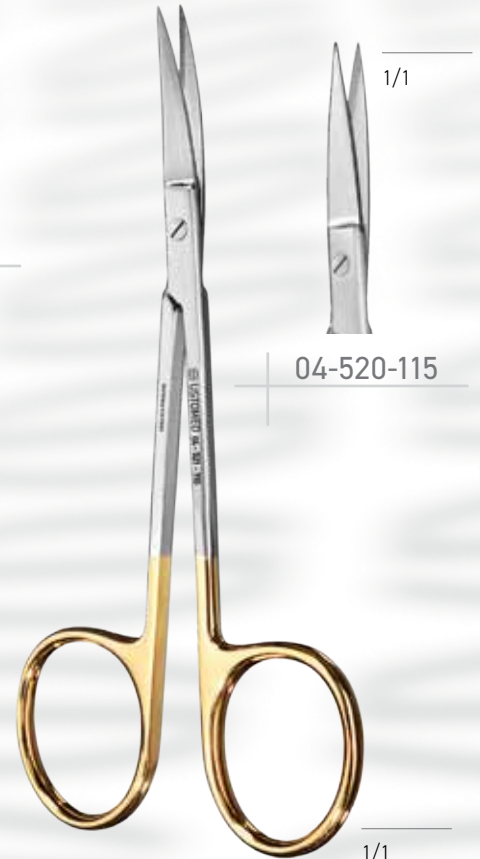

04-521-115
11.5cm, curved

05

MICRO SCISSORS



05

Micro Scissors

I'MOTION



05-803-180
18cm, curved



curved, round
05-809-145
14.5cm
05-809-180
18cm



05-621-145
14.5cm, very fine tips,
flat handle



05-801-145
14.5cm, x-fine tips, round

08

DISSECTING AND TISSUE FORCEPS

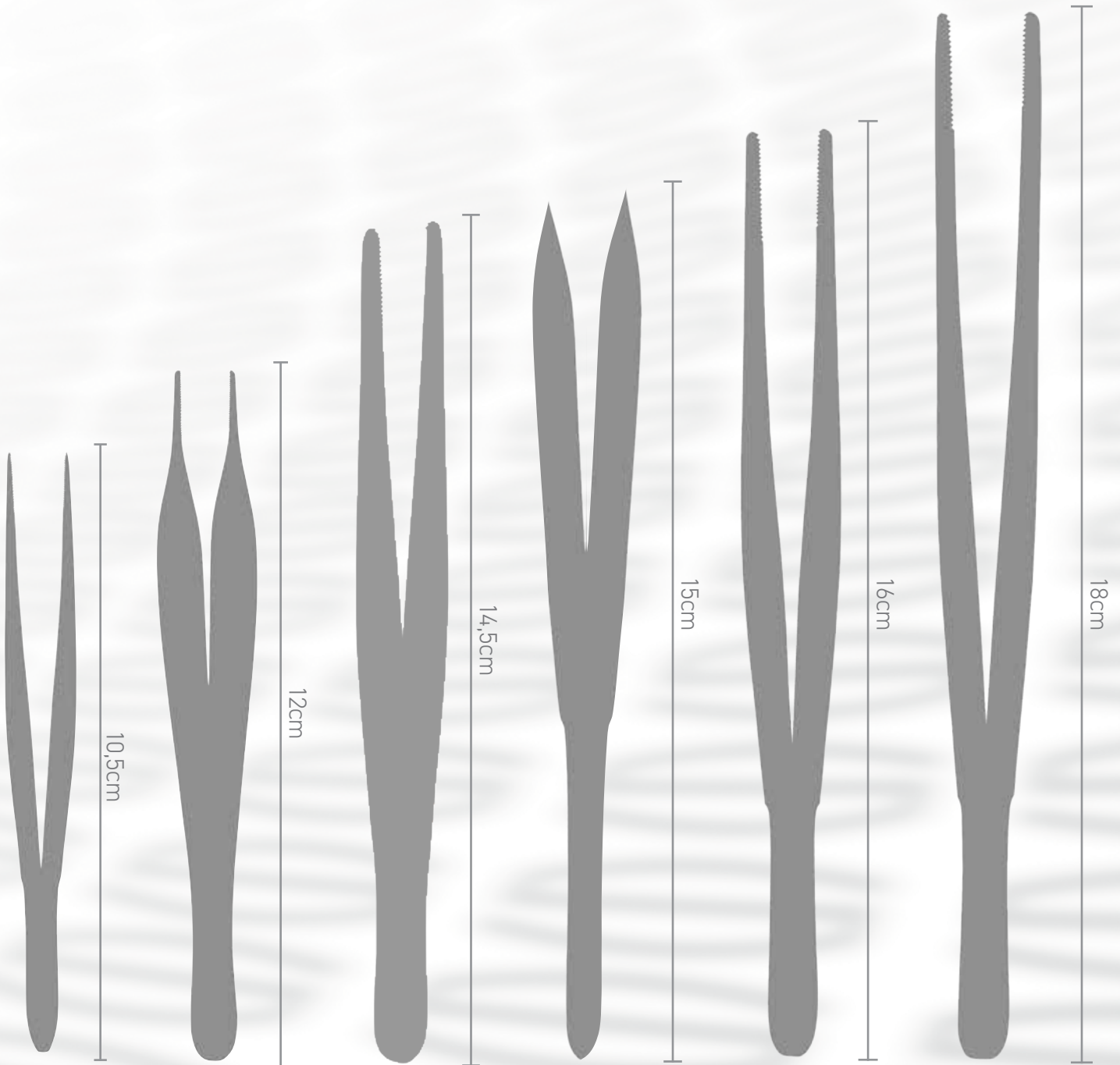

08

Dissecting Forceps



1/1



1/1



1/1



1/1

Dissecting forceps,
straight, standard

08-020-145

14,5cm

08-020-160

16cm

Dissecting forceps,
straight, delicate

08-030-145

14,5cm

08-030-160

16cm

08-030-180

18cm

Dissecting forceps,
curved, delicate

08-033-145

14,5cm

08-033-160

16cm

08-033-180

18cm

Dissecting forceps,
cross-serrated

08-036-145

14,5cm

08-036-160

16cm

08-036-180

18cm

ADSON

SEMKEN

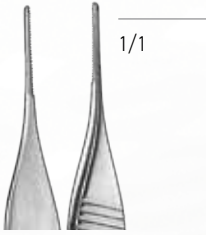

1/1

08-060-122



1/1



1/1



1/1



1/1

Dissecting forceps

08-060-120

12cm

08-060-150

15cm

08-062-150

MICRO-ADSON,
diss. forceps, 15 cm,
x-fine

08-080-155

Dissecting forceps,
15, 5 cm, straight

10-130-180

Dissecting forceps,
18 cm, delicate, TC

08

Tissue Forceps

GERALD

SEMKEN



1/1

Tissue forceps, straight,
1x2 t., v.delic.

08-235-145

14,5cm

08-235-160

16cm

08-235-180

18cm



1/1

08-281-155

Tissue fcps., 15, 5cm,
straight, 1x2 t.



1/1

08-301-175

Tissue forceps, 17,
5cm, str., 1x2 t.

ADSON

MICRO-ADSON

ADSON-BROWN

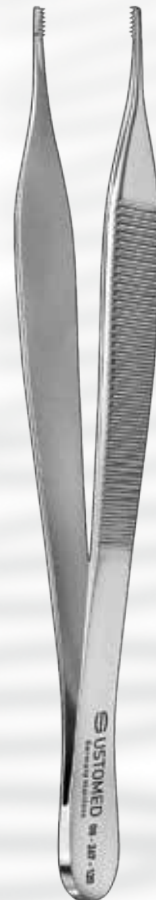

Tissue forceps, 1x2 teeth

08-261-120

12cm

08-261-150

15cm

Tissue forceps, 1x2 teeth, xfine

08-262-120

12cm

08-262-150

15cm

08-267-120

Tiss.forceps, 12cm, 7x7 teeth

09

MICRO AND ATRAUMATIC FORCEPS

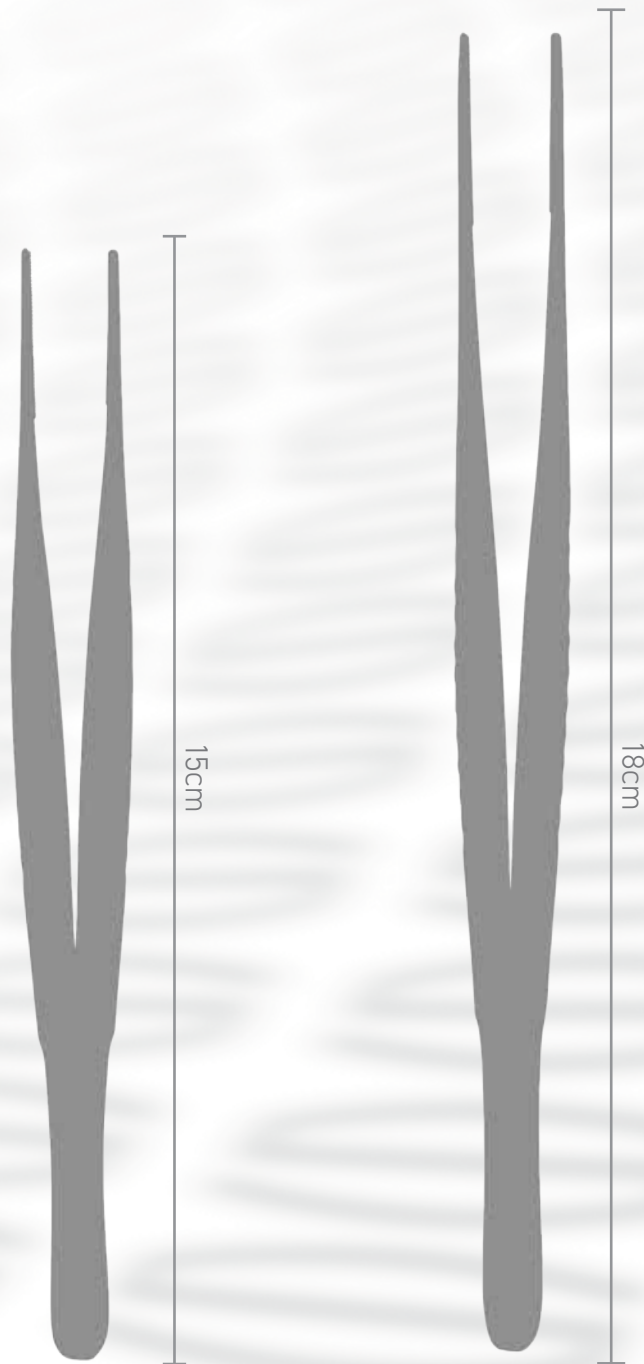

DE BAKEY - FOR TISSUES AND SUTURES



atraum. fcps., jaws 1,5mm

09-520-150

15cm

09-520-180

18cm

atraum. fcps. jaws 2,0mm

09-526-150

15cm

09-526-180

18cm

09-545-150

atraum. fcps., 15 cm,
angled, 2mm

09

Micro Forceps



1/1

09-230-180

Micro-dissecting forceps,
18 cm, diamond



1/1

09-267-180

Micro-tissue forceps, 18 cm,
cvd., 1, 2 mm



1/1

09-265-180

Micro-tissue forceps, 18 cm,
str., 1, 2 mm

DE BAKEY



1/1

09-270-180

DE BAKEY, micro atraum. fcps., 18cm, str.

I'MOTION



1/1

09-280-180

I'Motion, Micro-forceps, Cooley,

10

COLLEGE FORCEPS AND MEASURING INSTRUMENTS

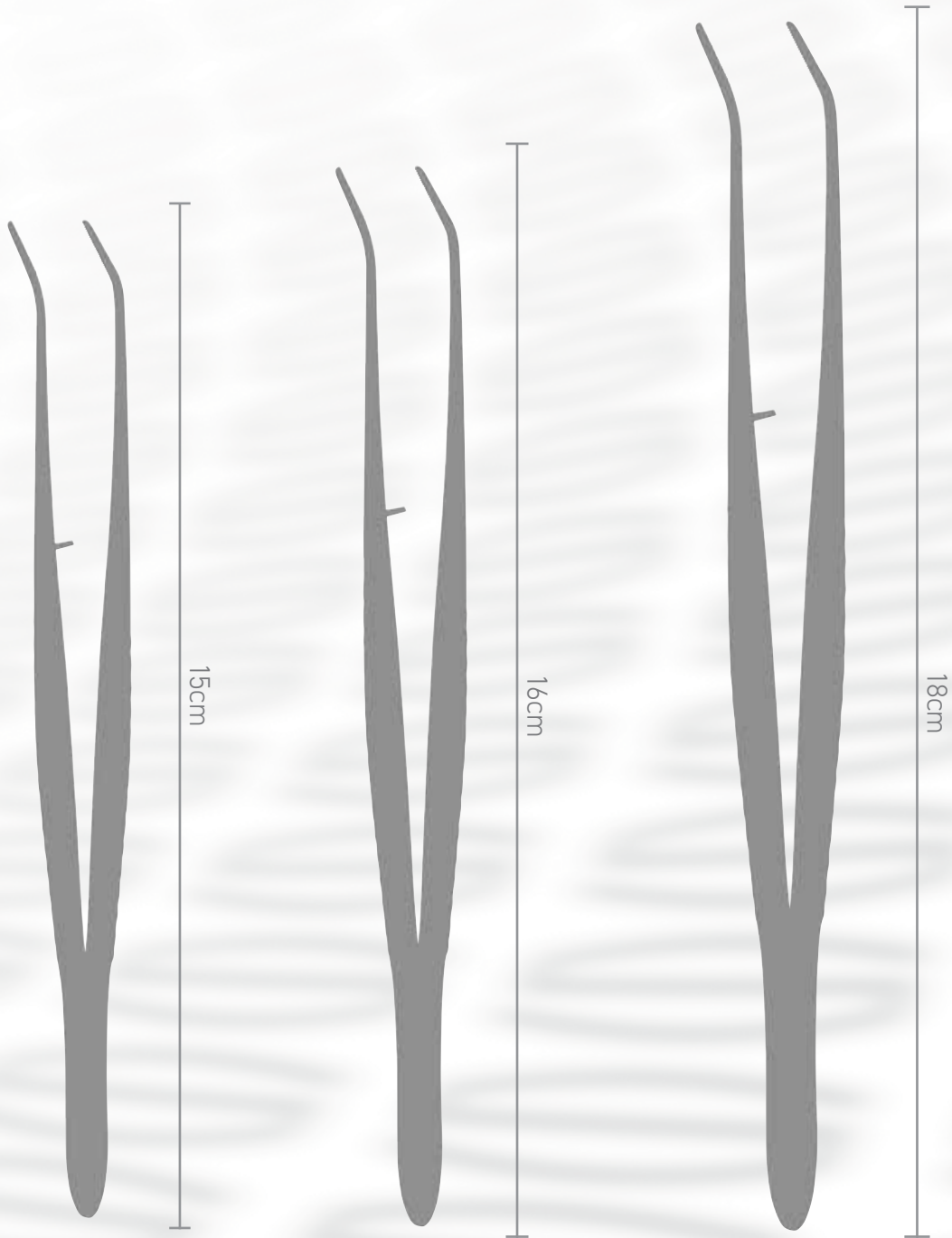

LONDON COLLEGE

LONDON COLLEGE modified



10-801-150

Tweezers, 15 cm, serrated jaws

Modif., tweezers, strong patt

10-825-150

15cm

10-825-160

16cm

10-825-180

18cm

10-827-150

Modif., tweezers, strong patt.diam

10-829-150

Modif., tweezers, counter-ang.

10

College Forceps

MERIAM



1/1

10-831-160

Tweezers, 16 cm,
serrated jaws

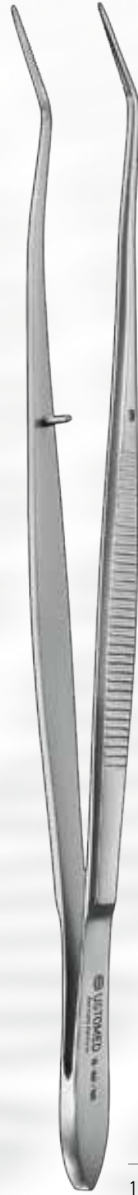

1/1

10-841-160

Tweezers, 16 cm, serrated
jaws

10-845-155

Modif., tweezers, smooth
handles

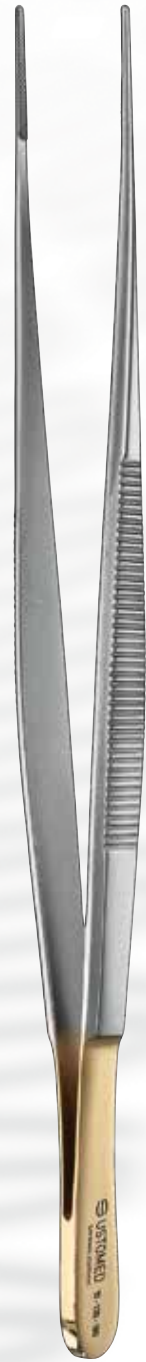

1/1

10-130-180

Dissecting forceps,
18 cm, delicate, TC



1/1

Splinter forceps, 10, 5 cm,
serr.

08-452-105

straight

08-453-105

curved



1/1

10-823-160

Maxgraft-Bone-Ring
forceps, 16 cm



1/1

10-871-160

Suture forceps, 16 cm, with
eye tips

10

Special Forceps and Tweezers

PONTE



1/1

10-877-160

PONTE, Bone-Block holding forceps, 16cm,



1/1

10-883-150

Nerve broach pliers, with lock

MILLER



1/1

10-947-150

MILLER, forceps for articulating paper



10-941-000

IWANSON, caliper, meas. range 0-10 mm



1/1

10-942-150

Ruler, 15 cm, metal



10-943-000

ZIELINSKY, measuring caliper

13

HEMOSTATIC FORCEPS



HALSTED-MOSQUITO



1/1

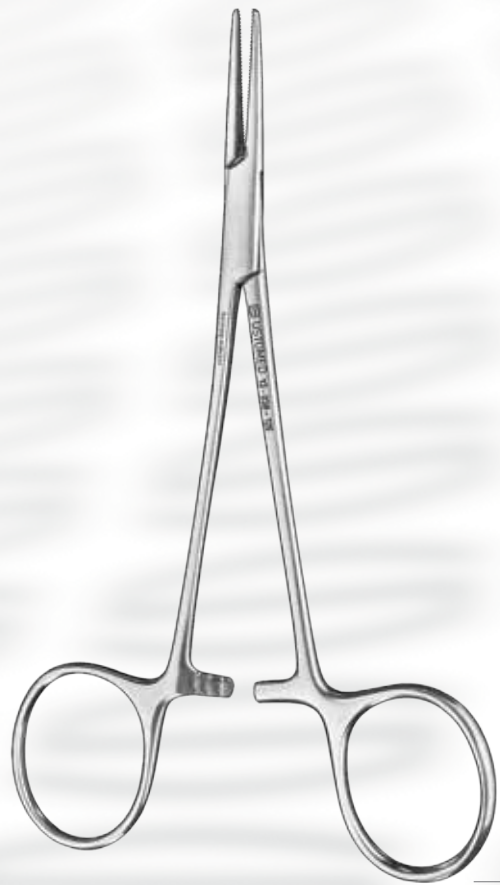

1/1

curved

13-039-

14 cm

13-039-125

12,5 cm

straight

13-038-125

12,5 cm

13-038-140

14 cm

13

Hemostatic Forceps

ROCHESTER-PEAN

MICRO-MOSQUITO

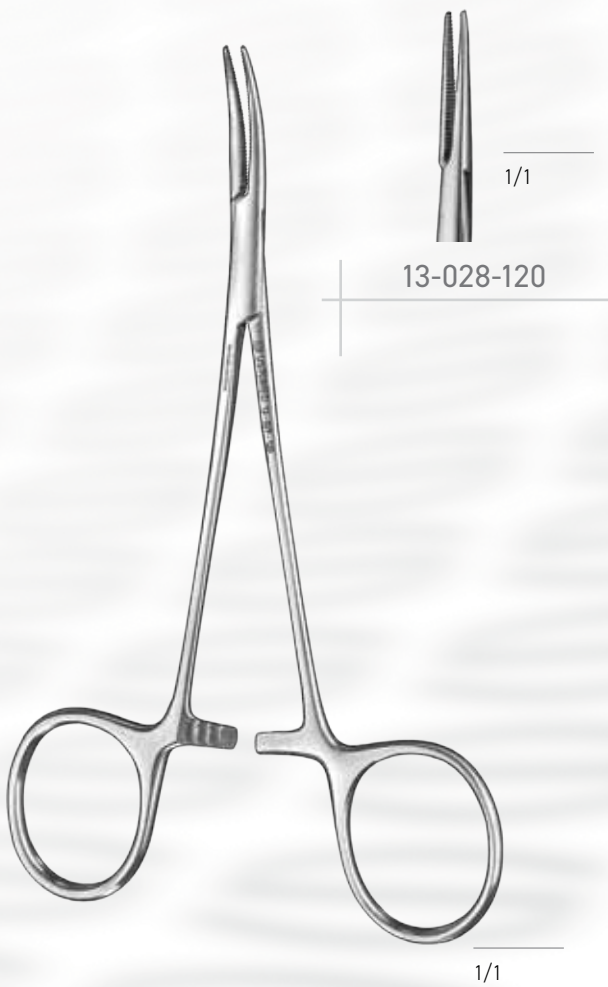

13-029-120
12 cm, curved



13-201-140
14 cm, curved

HALSTED-MOSQUITO

13-031-120

12 cm, curved, 1x2 teeth



1/1

OCHSNER-KOCHER

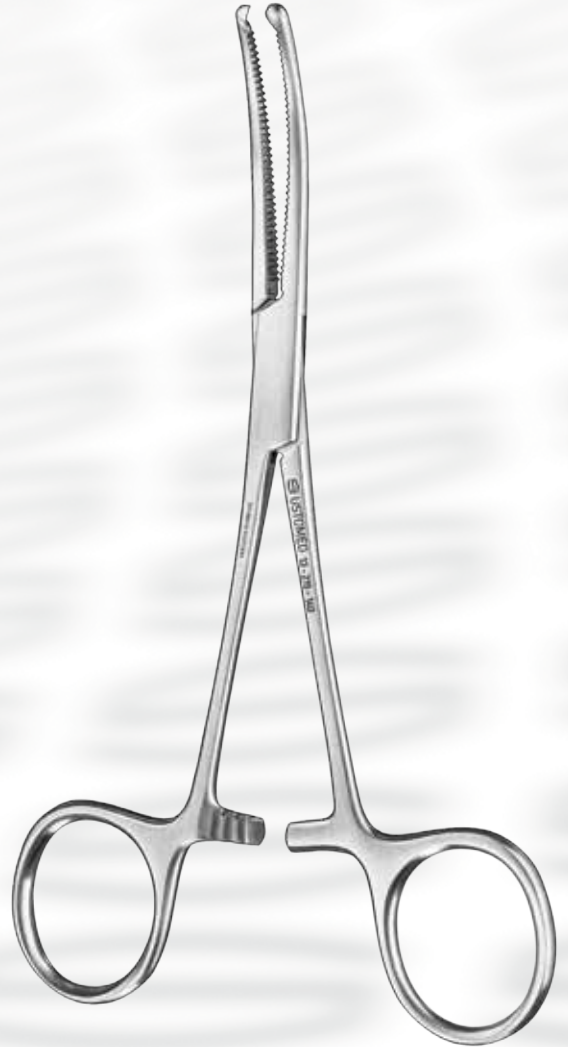

1/1

MICRO-MOSQUITO

HALSTED-

13-043-125

12,5 cm, curved

13-043-140

14 cm, curved

13-042-125

12,5 cm, straight



1/1

13-215-140

14 cm, curved, 1x2 teeth

19

NEEDLE HOLDER

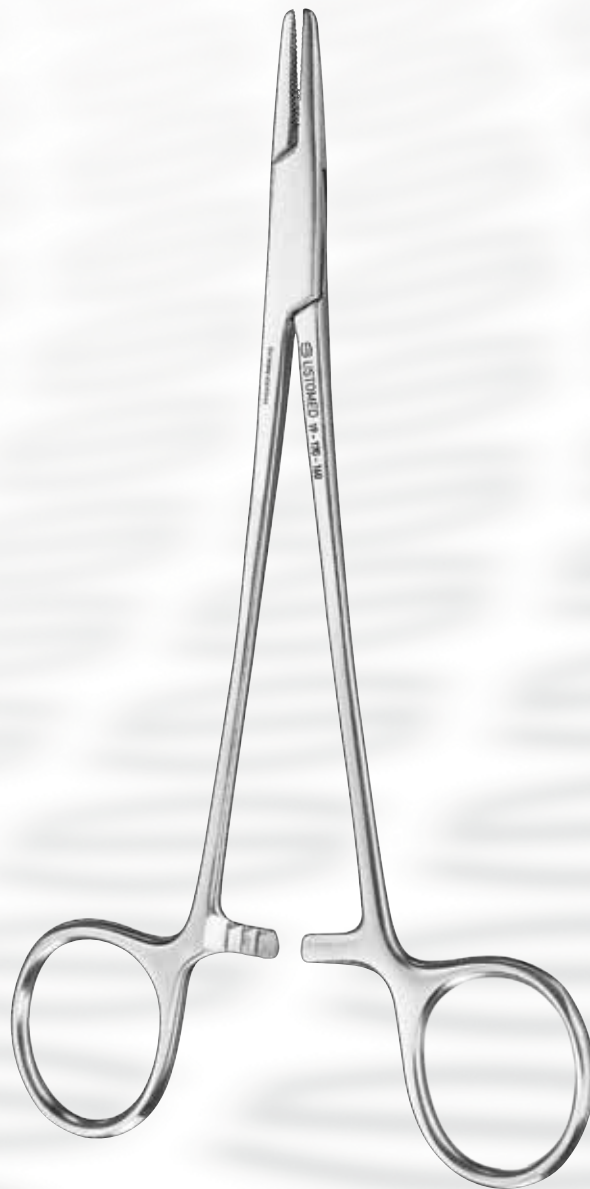



1/1

19-170-160

16 cm



1/1

19-300-140

14 cm

19-300-170

17 cm

20 TC NEEDLE HOLDER

TC = TUNGSTEN CARBIDE

An extremely durable metal, that is harder than most common suture-needles! This inlay increases the longevity of our needle holders dramatically. The inlays are able to change.

The gold-plated handle indicates TC inserts.

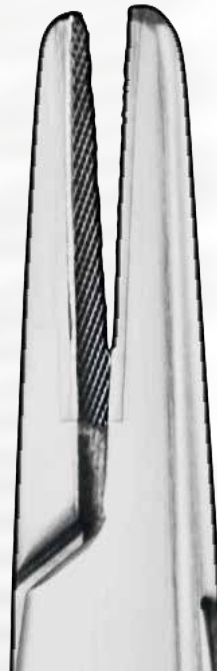

HALSEY

BABY-CRILE-WOOD



1/1

20-120-130

13 cm

3/0 - 5/0



1/1

20-160-150

15 cm

4/0 - 5/0

20

TC Needle Holder

CRILE-WOOD



20-164-150

15 cm

) 3/0 - 5/0



20-164-180

18 cm

) 3/0 - 5/0

MAYO-HEGAR

MICRO-RYDER



1/1

20-220-160

16 cm

) 2/0 - 4/0

20-220-180

18 cm

) 2/0 - 4/0



1/1

20-320-150

15 cm

) 5/0 - 7/0

20-320-130

13 cm

) 6/0 - 7/0

MATHIEU MODIFIED



INFO
 modified lock mechanism prevents the glove to get caught in the lock.

- 20-452-170
17 cm 3/0 - 4/0

- 20-452-140
14 cm 3/0 - 4/0

- 20-452-200
18 cm 3/0 - 4/0

LICHTENBERG



1/1
 20-471-170
 17 cm, curved

- 20-470-170
17 cm, straight 3/0 - 4/0

HÖSEL



20-480-200

20 cm, straight, extra-long) 3/0 - 4/0

20

TC Needle Holder

LANGENBECK



1/1

20-392-160

16 cm

) 3/0 - 5/0

20-392-180

18 cm

) 3/0 - 5/0

TOENNIS



1/1

20-398-180

18 cm

) 3/0 - 4/0

CASTROVIEJO

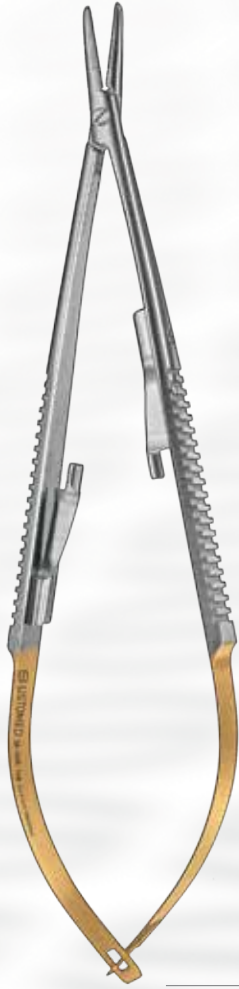

1/1



1/1

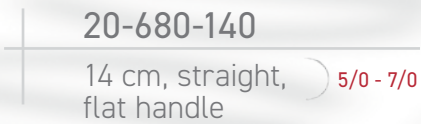

5/0 - 7/0

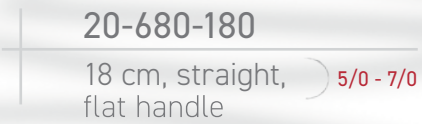

5/0 - 7/0

BARRAQUER



20-710-140

14 cm, straight,
round handle

5/0 - 7/0

20-710-180

18 cm, straight,
round handle

5/0 - 7/0

20-711-140

14 cm, curved,
round handle

5/0 - 7/0

20-711-180

18 cm, curved,
round handle

5/0 - 7/0

I'MOTION



1/1



1/1

20-752-180

18 cm, straight

INFO

- extremely light
- plasma-coated tips
- easy to clean

20-753-180

18 cm, curved

5/0 - 7/0

24

RETRACTORS



GILLIES

KILNER



24-421-150

15 cm, 1 fork, sharp



Fig. 1

24-425-001

18 cm, size 1, small



Fig. 2

24-425-002

18 cm, size 2, large

24

Tissue Retractors

JOSEPH

GUTHRIE



24-469-002

15 cm, 2 forks, sharp



24-573-002

16 cm, 2 forks, 2 mm

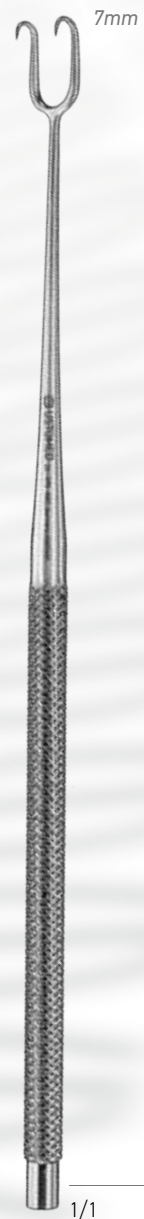

24-573-007

16 cm, 2 forks, 7 mm



24-021-001

single fork, 16 cm, sharp



24-021-002

double fork, 16 cm, sharp



24-023-001

single fork, 16 cm, blunt

24

Cheek Retractors

MINI- LANGENBECK

CAWOOD- MINNESOTA

GIERL



24-153-000
Cheek Retractor

24-154-160
16 cm

24-157-155
15,5 cm



84-239-000

GLUCKMANN, PET-Shield holder, double-sided



INFO

Special tool for the Advanced Socket Shield Technique: „PET“ by Dr. Howard Gluckman.

Helps you to secure the gingiva, when preparing the buccal root during the procedure.



24-158-002

PET Shield, right



24-158-001

PET Shield, left

24

Cheek Retractors

MIDDELDORPF

HILGER



24-159-001

Cheek Retractor,
only, compatible
to mouth mirror
handles

24-159-000

Cheek Retractor,
complete with handle



24-161-002

22 cm, size 2, medium

LANGENBECK

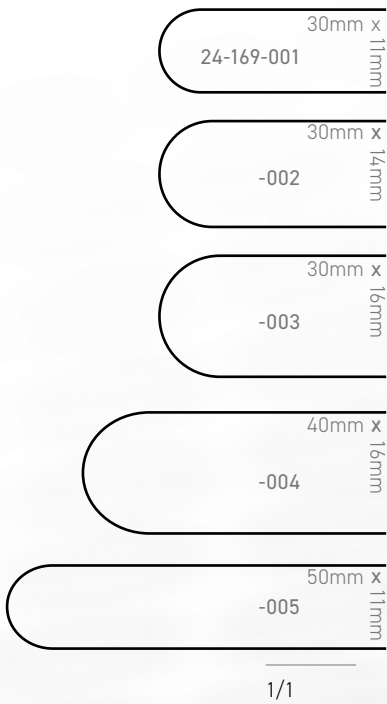

Wound Retractor
21 cm

KOCHER

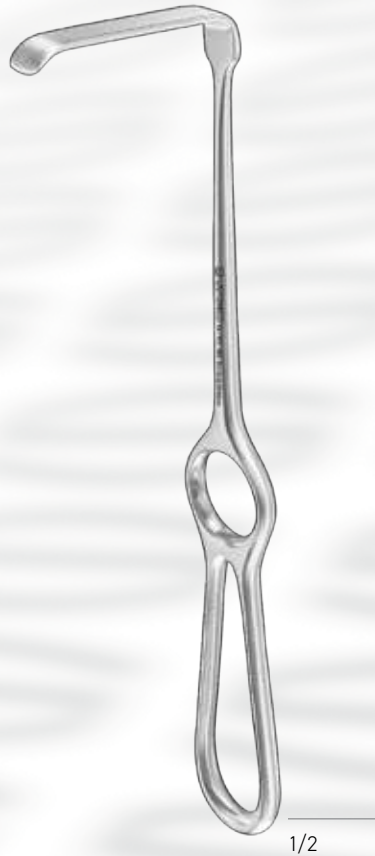
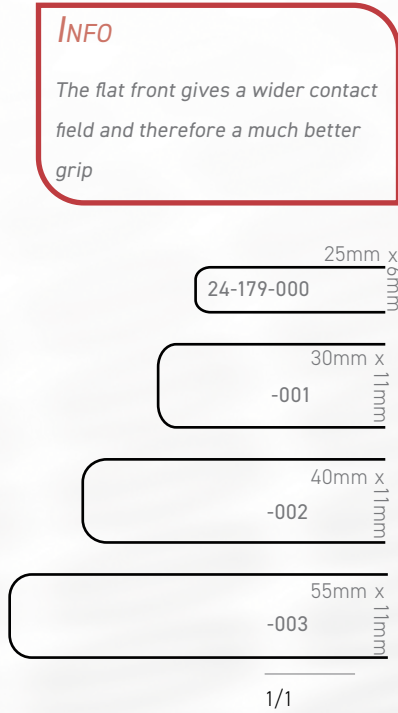

Wound Retractor
22 cm

OBWEGSER

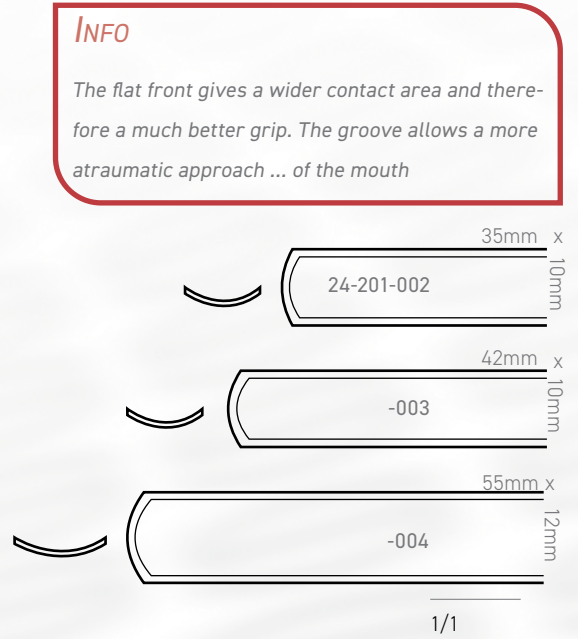

Wound Retractor
24 cm

24

Wound & Special Retractors

KOCHER- TROSSBACH



3/4

24-179-

size 3, 55 x 11mm,
bended upwards

NENTWIG



3/4

24-191-230

Zygomatic Retractor,
23 cm



3/4

24-191-014

Special Retractor,
70x14mm, serrated

USTOMED

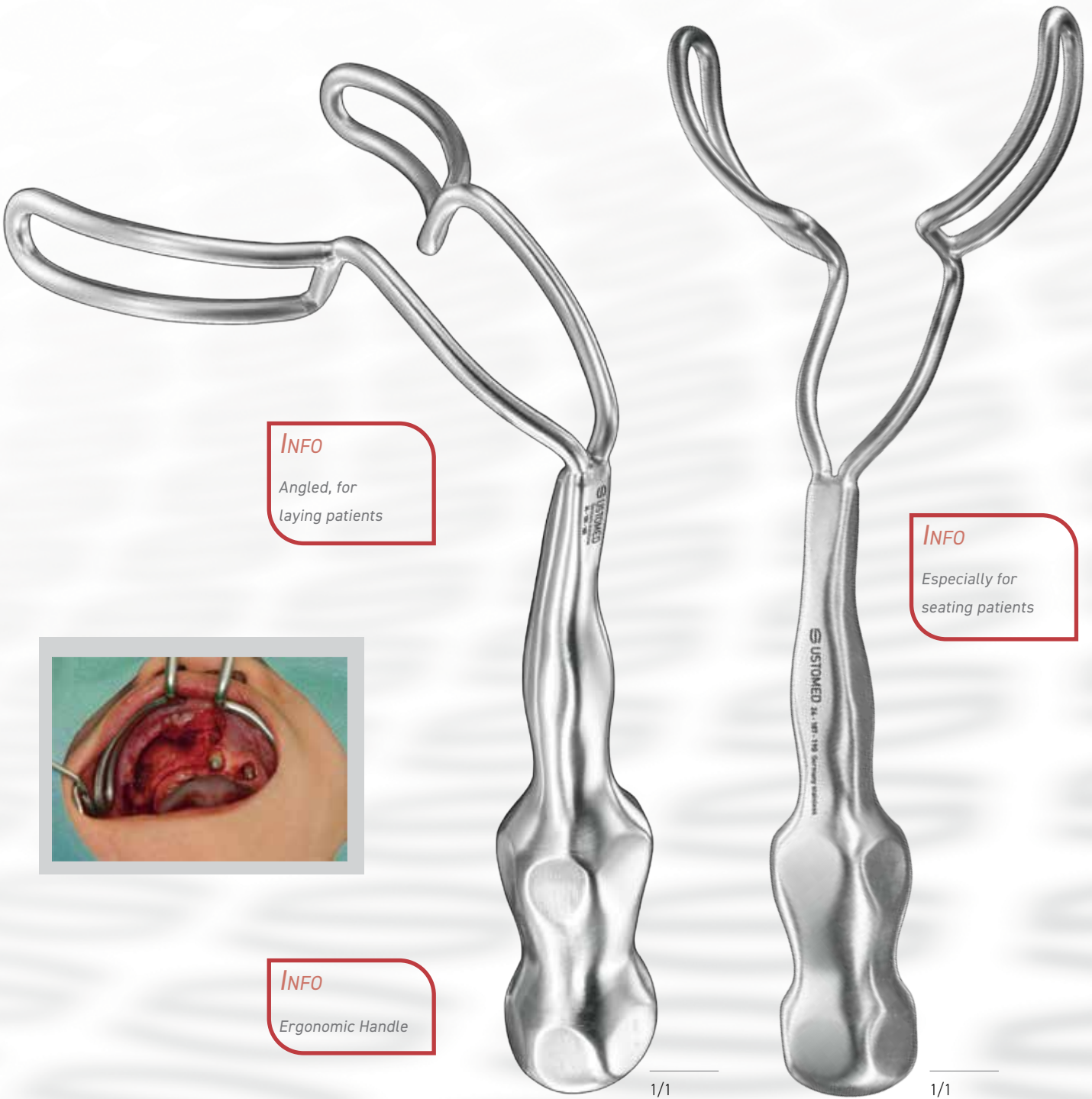

INFO
 Angled, for
 laying patients

INFO
 Especially for
 seating patients



INFO
 Ergonomic Handle

1/1

1/1

24-189-180
 universal, angled

24-187-
 universal, straight

LASTER

BRAANEMARK

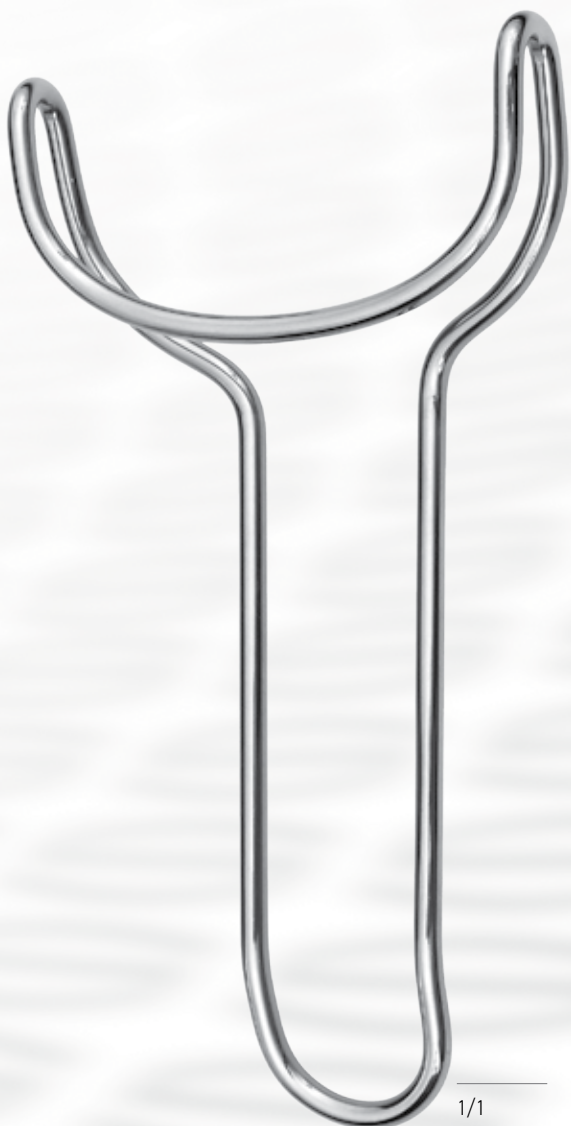

1/1

24-186-150

80mm



1/1

24-203-105

Retractor, for upper impacted wisdom

HILGER



24-197-001

cheek and lip spreader,
size 1

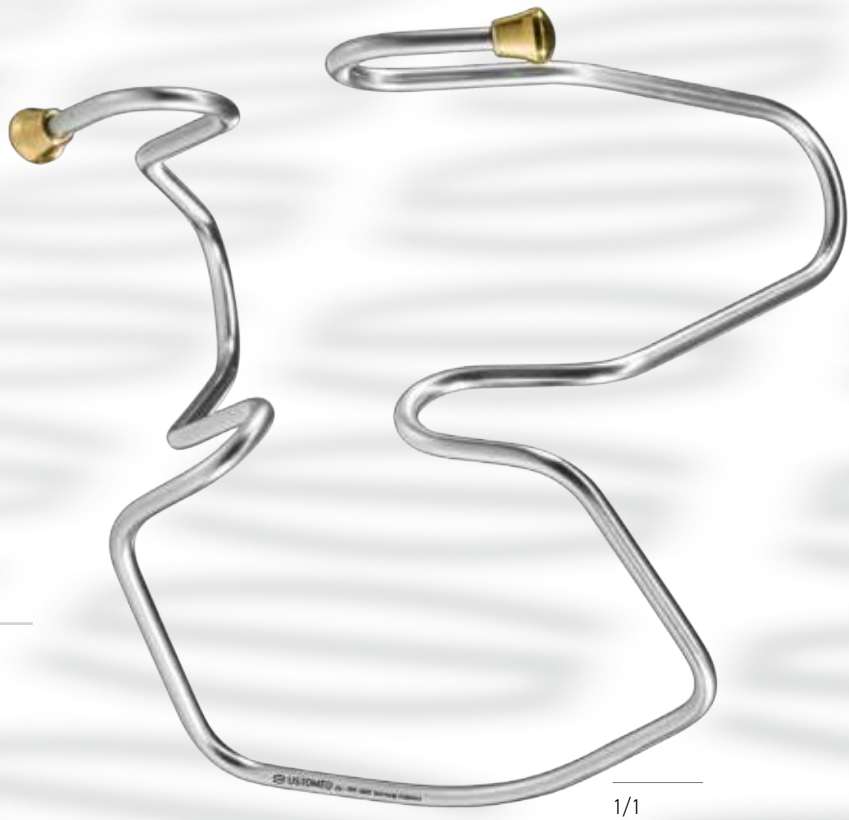

24-197-002

cheek and lip spreader,
size 2

INFO

Cheek and lip spreaders self-expanding, plastic material, autoclavable up to 180° C.

SPANDEX



1/1

24-395-001

size 1, pack of 2



1/1

24-395-002

size 2, pack of 2

27

ELEVATORS AND RASPATORIES



OBWEGESER

WILLIGER

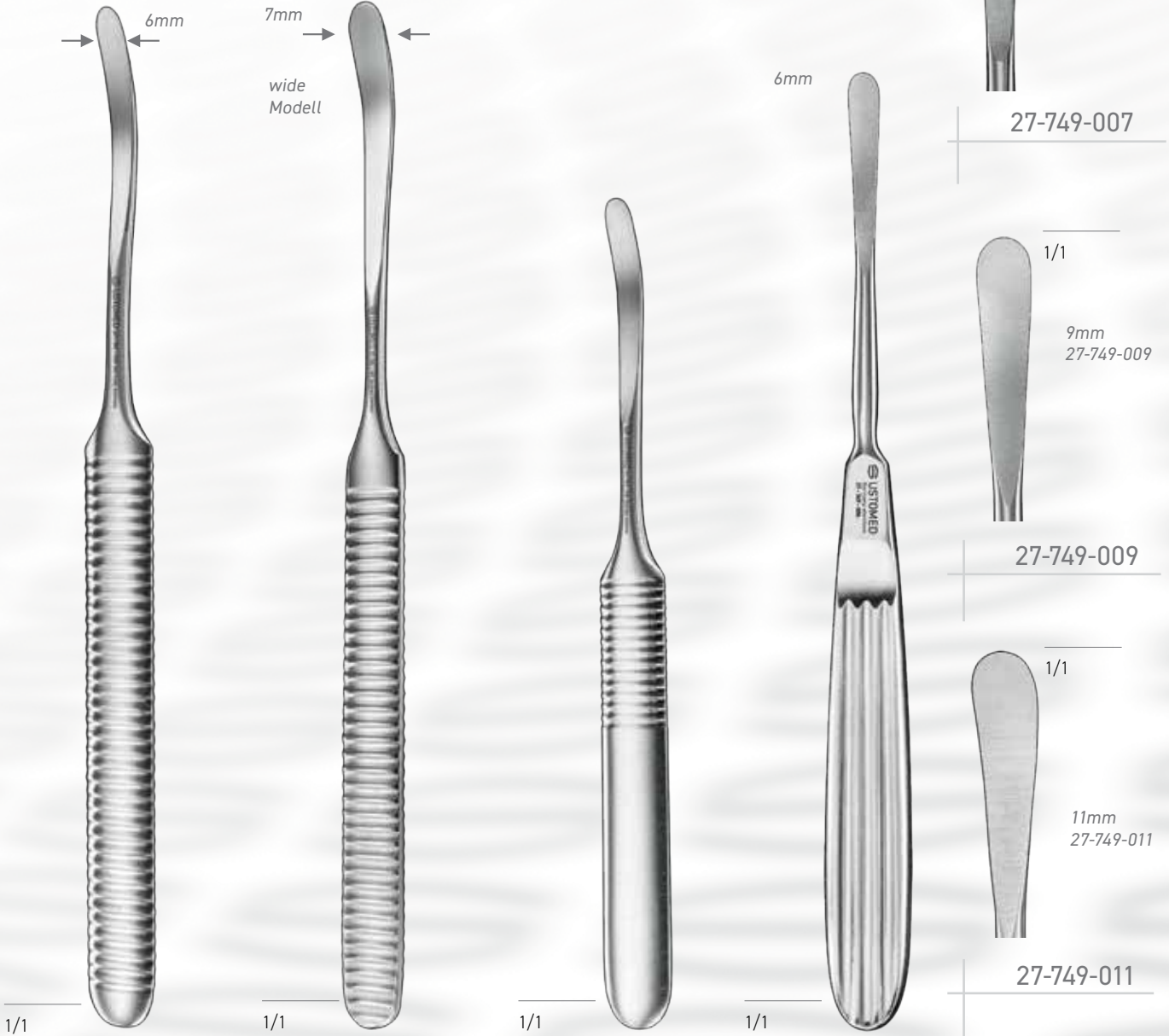

27-741-160

Raspatory,
16 cm,
curved

27-745-160

Raspatory,
16 cm,
curved, wide

27-743-130

Raspatory,
13 cm,
curved

27-749-006

Raspatory,
17,5 cm, 6mm

PRICHARD

5mm, blunt



1/1

27-451-180

Elevator, 18 cm, double-ended, sharp/blunt

27-451-180POT3

Elevator, 18 cm, double-ended, sharp/blunt, peek handle

INFO

Mini Retractor



1/1

27-459-175

Raspatory PR3, 17,5 cm, double-ended

27-459-175POT3

Raspatory PR3, 17,5 cm, double-ended, peek handle

4mm



1/1

27-717-175

Raspatory, 17,5 cm, double-ended, curved

27-717-175POT3

Raspatory, 17,5 cm, double-ended, curved, peek handle

27

Elevators and Raspatories

PARTSCH

MOLT

GLICKMAN



27-711-024

Raspatory No.24G, 16,5 cm



67-711-002

PARTSCH, Raspatory,
one-sided



27-721-190

Raspatory, 19 cm,
double-ended, curved

ZUCHELLI



1/1

INFO
black coated tips, allow better visuability under gingiva



1/1

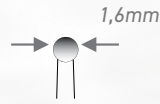

1/1



85-814-175P0T3

 Mod. Z, peek handle

85-812-175P0T3

Mod. W, peek handle

85-812-175

Mod. W, peek

KASAJ

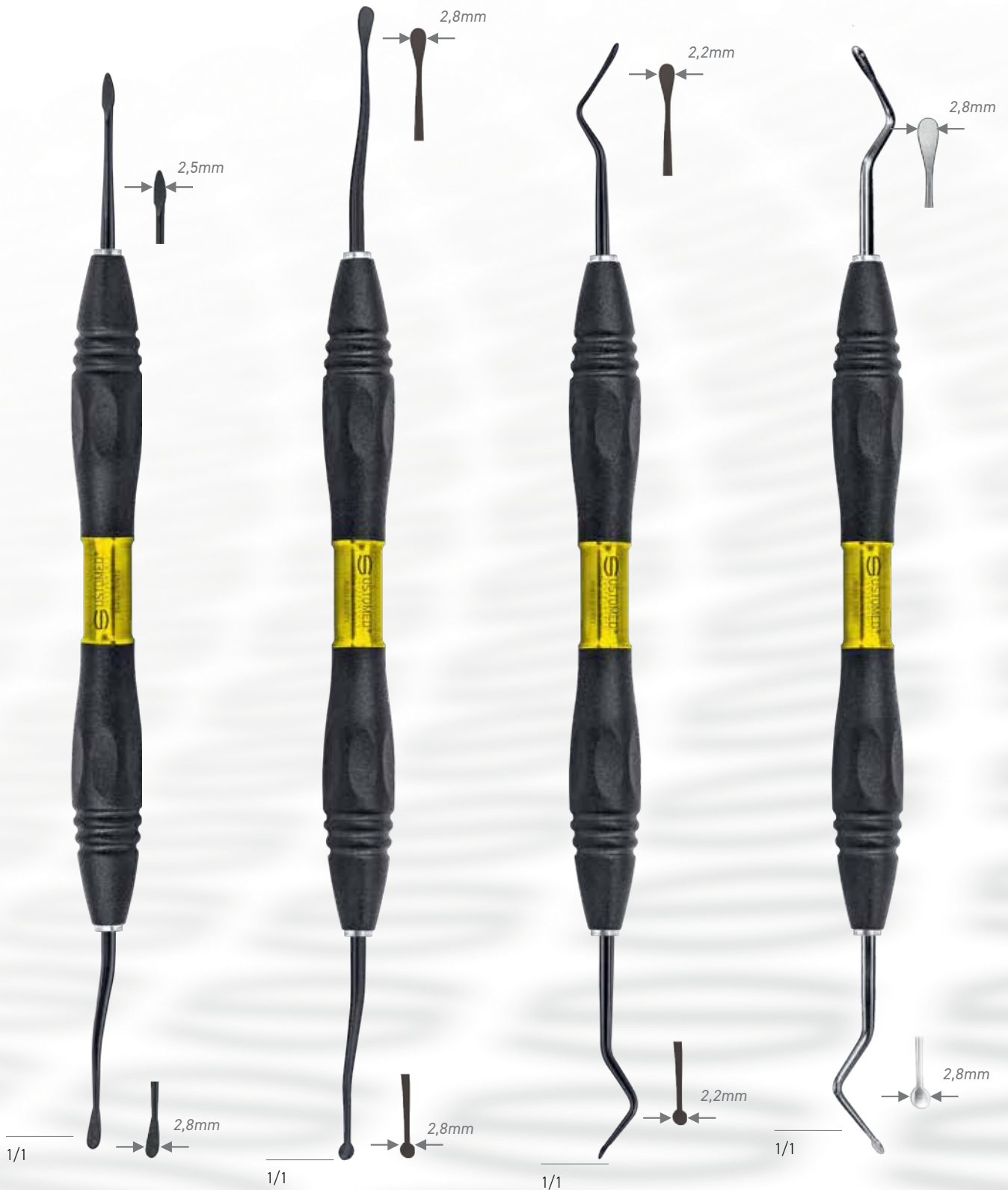

85-816-170P0T3

Mod. B,

85-818-001P0T3

Tunnelling knife,
micro, 20cm,
posterior, peek

85-818-002P0T3

Tunnelling knife,
micro, 19cm,
anterior, peek

85-818-175P0T3

Tunneling knife,
19 cm, anterior,



1/1

85-816-175

Mod. B, 17,5 cm,
peek handle



1/1

85-816-175P0T3

Mod. B, 17,5 cm



1/1

85-808-175P0T3

Mod. W, 18,5 cm



1/1

85-808-175

Mod. W, 17,5 cm,



31

BONE RONGEURS



MICRO

FRIEDMAN

LUER



1/1



1/1



1/1

31-319-145

14cm / 25° curved

31-321-140

Bone rongeur, 14 cm,
curved

31-379-150

16 cm, curved, medium

31

Bone Rongeurs

BEYER

DELICATE



31-315-150

15 cm, curved



31-421-180

Bone Rongeur, 18 cm,
curved, transmitted

42

MEASURING DEVICES

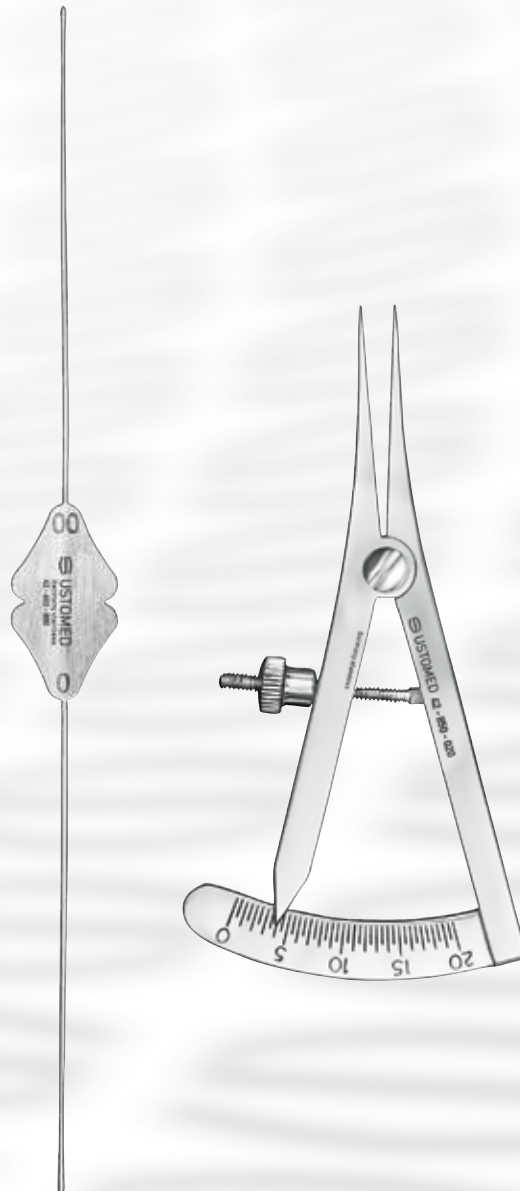

BOWMAN



1/1

Antrum probe, ball-point

42-652-000
size 00/0



42-652-012
size 1/2



42-652-034
size 3/4



42-652-056
size 5/6

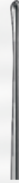

42-652-078
size

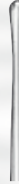

42-652-300
sz.000/00



42-652-400
0000/000



CASTROVIEJO

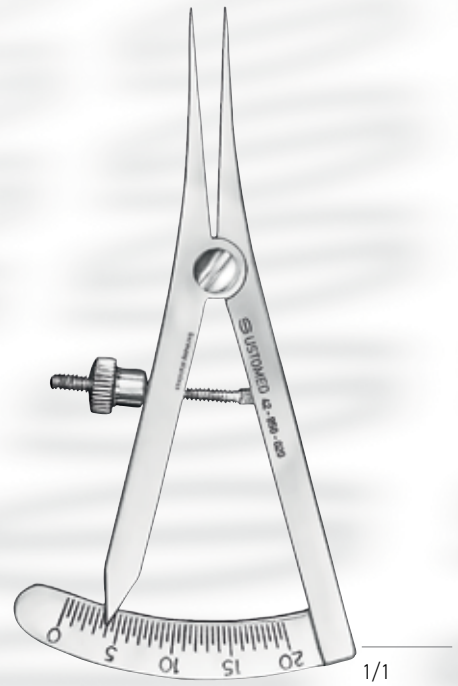

1/1

42-850-020

Implantology caliper,
20 mm, straight

46

SINUS CURETTES



KHOURY SEMI-SHARP



46-695-004
Sinus Curette, Fig. 4, 180 mm, semi-sharp



46-695-004POT3
Sinus Curette, Fig. 4, 180 mm, semi-sharp, peek handle



46-695-003
Sinus Curette, Fig. 3, 180 mm, semi-sharp



46-695-003POT3
Sinus Curette, Fig. 3, 180 mm, semi-sharp, peek handle

HOTZ

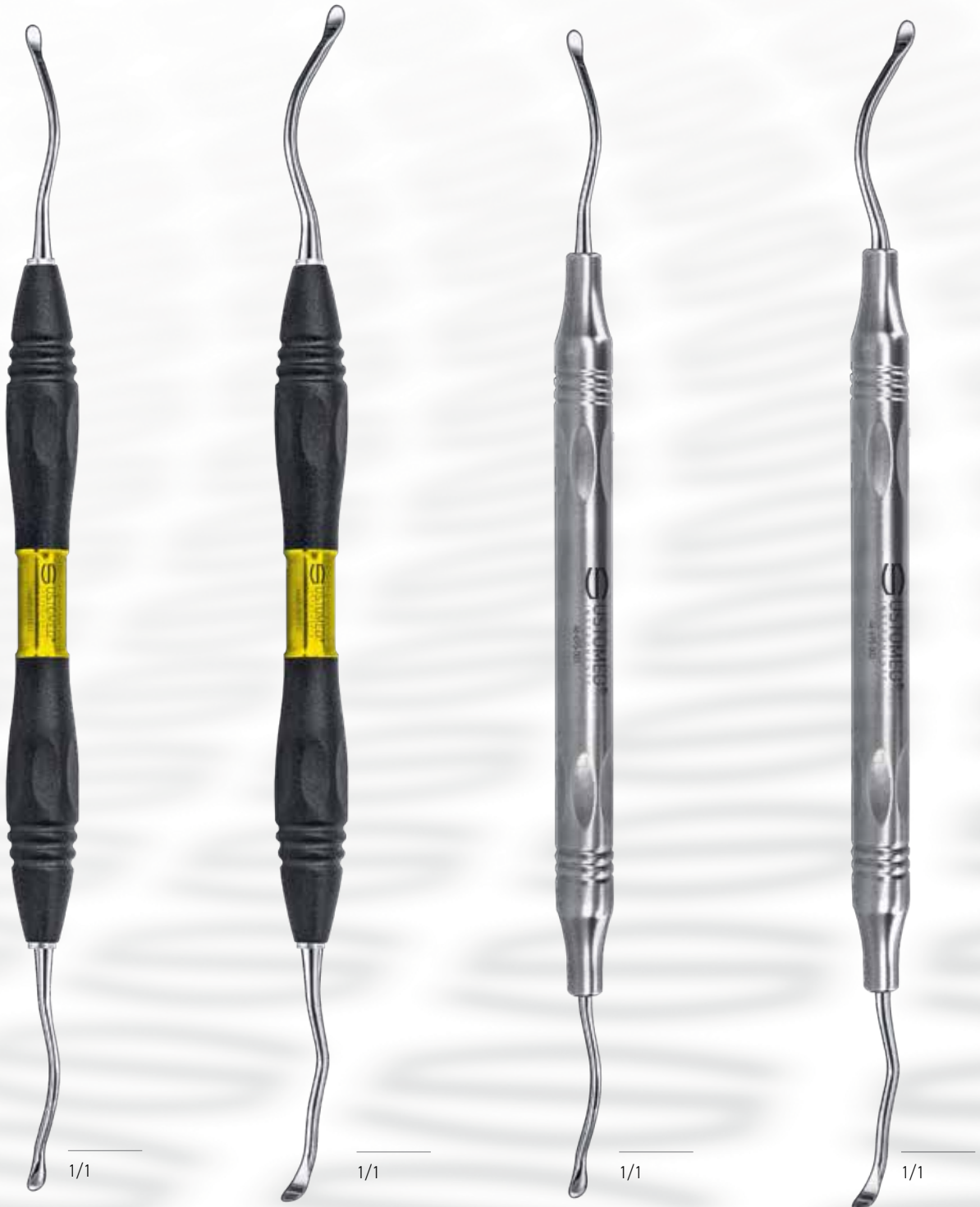

46-695-001POT3

Sinus Curette, Fig. 1,
185 mm, semi-sharp

46-695-002POT3

Sinus Curette, Fig. 2,
190 mm, semi-sharp

46-695-001

Sinus Curette, Fig. 1,
185 mm, semi-sharp

46-695-002

Sinus Curette, Fig. 2,
190 mm, semi-sharp

46

Sinus Curettes

NENTWIG SHARP

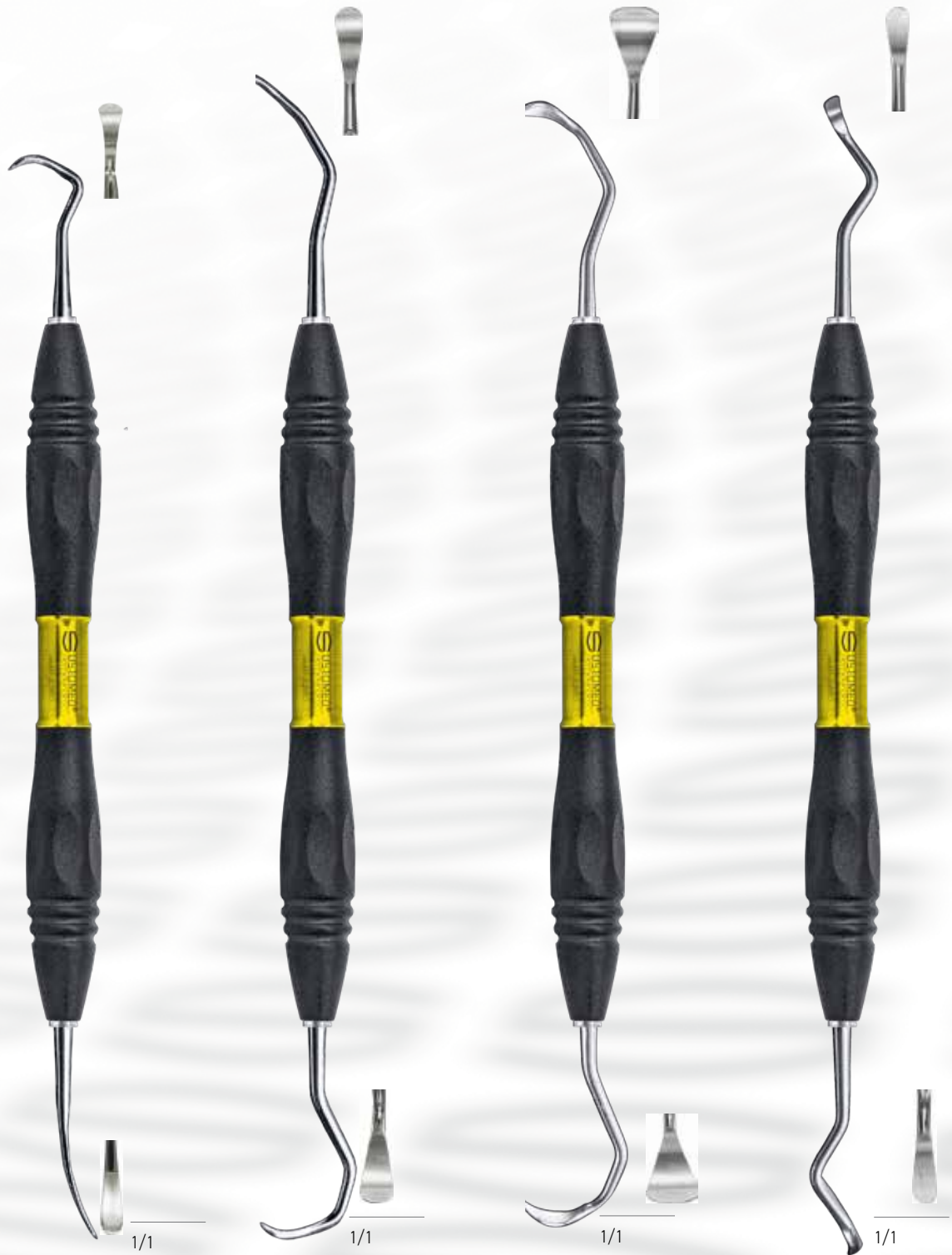

46-699-001POT3

Sinus Curette, Fig. 1,
180 mm, sharp, peek
handle

46-699-002POT3

Sinus Curette, Fig. 2,
190 mm, sharp, peek
handle

46-699-003POT3

Sinus Curette, Fig. 3,
190 mm, sharp, peek
handle

46-699-004POT3

Sinus Curette, Fig. 4,
190 mm, sharp, peek
handle

67/68

BONE PREP INSTRUMENTS AND TOOLS



DEGIDI



1/1

67-693-012P0T3

DEGIDI Pluggers,
size 1/2, peek
handle



1/1

67-693-034P0T3

DEGIDI Pluggers,
size 3/4, peek
handle

INFO

Special instruments for
filling and condensing bone
material around an implant.

RHODES



1/1

67-545-367P0T3

Back-Action Chisel,
size 36/37, peek
handle



1/1

85-802-305P0T3

Bone Scraper, Mod.
B, 3 and 5 mm
width, peek handle



1/1

67-691-003P0T3

Filler and Plugger for
biomaterials, peek
handle



1/1

67-691-008P0T3

Filler and Plugger for
biomaterials, peek
handle

MINI-LAMBOTTE



67-555-004 S

13 cm, 4 mm,
curved, scaled

67-554-004S

13 cm, 4 mm,
scaled, straight

67-555-006 S

13 cm, 6 mm,
curved, scaled

67-554-006S

13 cm, 6 mm,
scaled, straight

67-555-008 S

13 cm, 8 mm,
curved, scaled

67-554-008S

13 cm, 8 mm,
scaled, straight

67-555-010 S

13 cm, 10 mm,
curved, scaled

67-554-010S

13 cm, 10 mm,
scaled, straight



1/1

67-711-002

size 2, 15 cm



67-678-170

Bone Grinding Pliers

NENTWIG

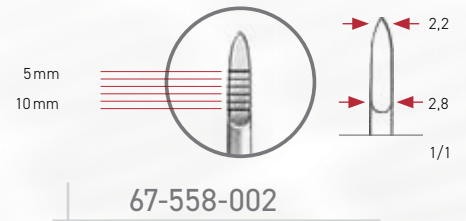
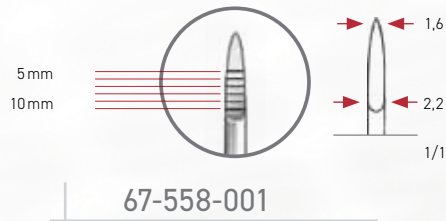

Localized spreading of the narrow ridge



67-558-444

Set, size 1-4, straight, scaled

NENTWIG

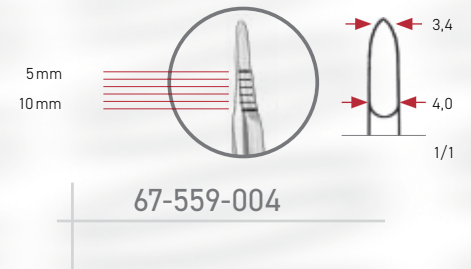
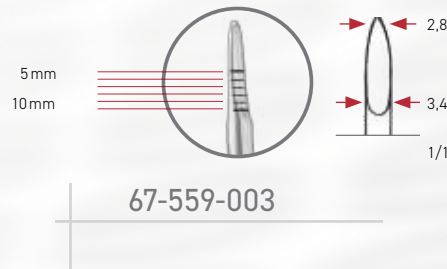
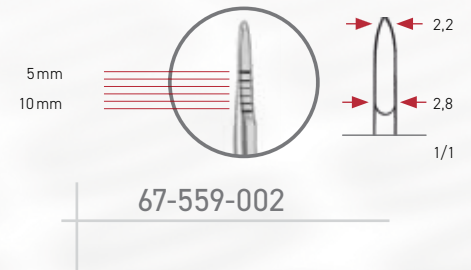
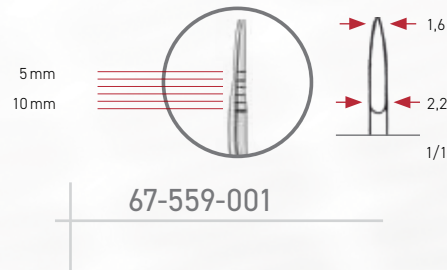

Condensing: preparation of the implant site when bone structure is compromised



67-559-444

Set, size 1-4, bajonet, scaled

67

Mallets

INFO
exchangeable
teflon inlays

67-636-002
Teflon Discs, for
67-636-210, 2 pcs.

INFO
Completely
made from steel

INFO
Most common
malett for use
with pins



1/1

67-660-150
16,5 cm, 150 g



1/1

67-636-210
18,5 cm, 210 g, Ø 25 mm

OMBREDANNE



1/1

67-670-720
26 cm, 720 g

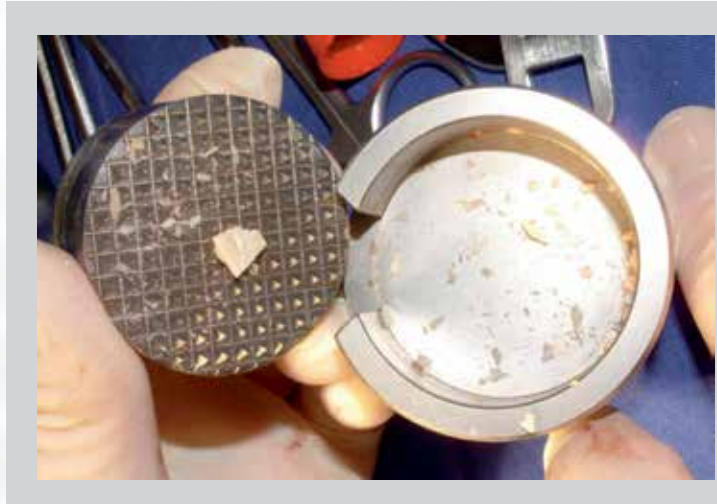

Photo Copyright Dr. Ponte



1/1

67-680-000
Bone crusher, round

LUCAS

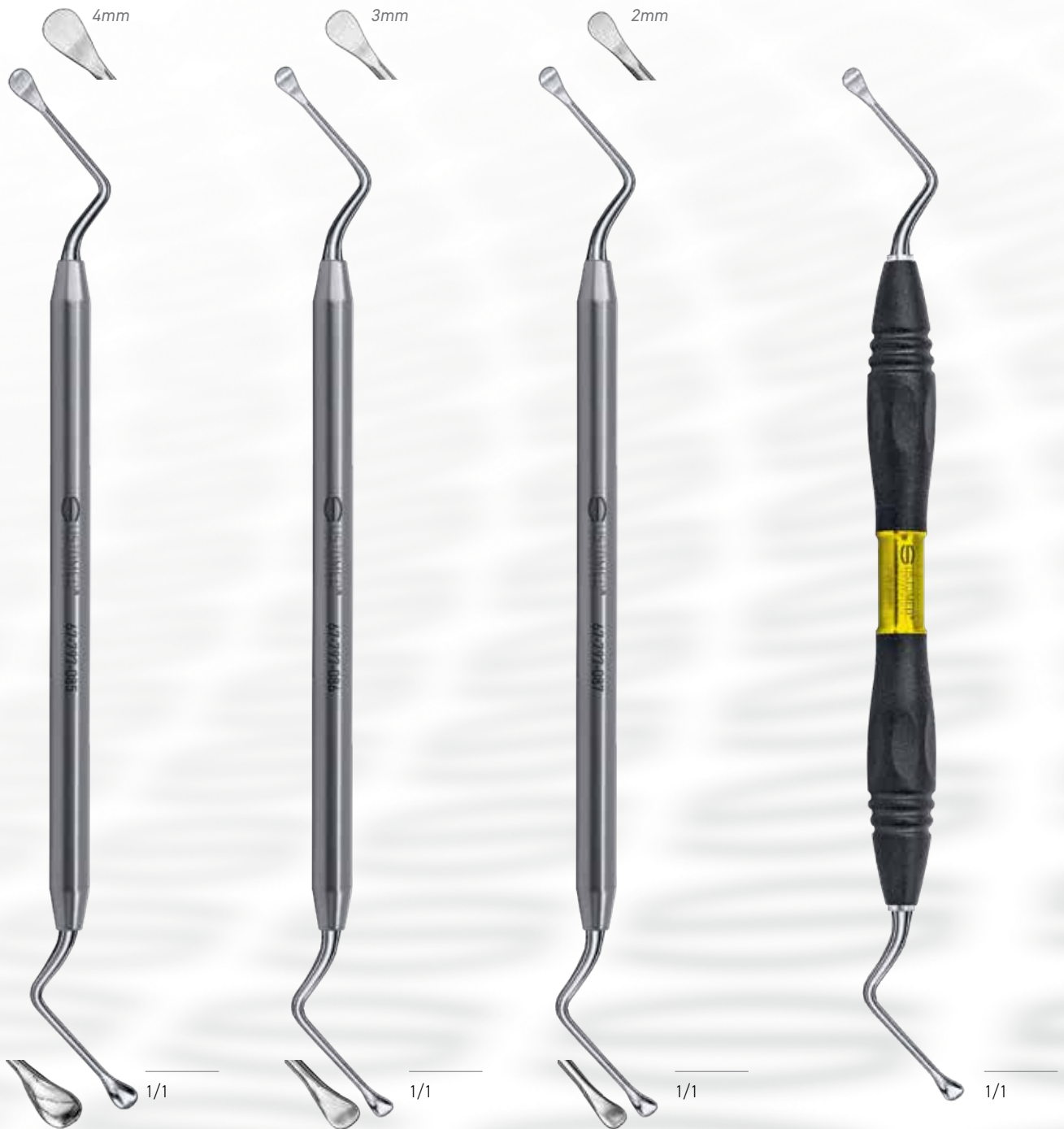

67-797-085

size 85, 17
cm, double-
ended

67-797-085P0

peek handle

67-797-086

size 86, 17 cm,
double-ended

67-797-086P0

peek handle

67-797-087

size 87, 17 cm,
double-ended

67-797-087P0

peek handle

67-797-186P0T3

size 86, 17 cm,
double-ended,
serrated

HEMINGWAY



18cm, double-ended

67-799-000
size 0



67-799-010
size 1



67-799-020
size 2



67-799-030
size 3



67-799-040
size 4



67-799-010P0
size 1



67-799-020P0
size 2



67-799-030P0
size 3



67-799-040P0
size 4



18cm, double-ended
67-799-000P0
size 0, peek handle

1/1

1/1

67

Bone Condenser, Osteotomes

INFO
Suitable for internal Sinus Lift.

INFO
Stopper is adjustable seamlessly.



INFO
Infinitely variable adjustment.



67-851-030
Ø 3,0 mm

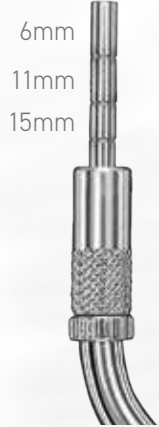

67-851-033
Ø 3,3 mm



67-851-040
Ø 4,0 mm

67-851-020

Bone Condenser, bajonet, concave, Ø 2,0 mm

USTOMED TITAN-PIN-SET

68-780-018

Titan-Pin-Set,



SET INCLUDES:



TITAN-PINS

68-620-003

Titan-Pins, 3mm, 10 pcs.

INFO

Suitable mallet 67-660-150
(see page 98)

APPLICATOR

- Single-piece instruments to collect the pins from the holding tray therefore the twisting of the working tip during the operation is excluded.
- Very ergonomic and comfortable Grip for a safe operation of the Titan-Pins

68-650-000

Applicator, for pins 68-620-003, 15,5cm

HOLDING TRAY

- Functional Design
- safe and easy to operate with single hand principle
- Box can contain up to 15 Titan-Pins

68-720-008

Box for 15 Titan-Pins

68-780-016

Bone-Fixation-Set, Titan,
1,2mm / 1,4mm Ø

**CONTENTS:**

- 68-720-002 Box for Micro-Screws Ø 1,0/ 1,2/ 1,4mm
- 68-740-002 Screwdriver, 11cm, Fig. 2
- 68-760-102 Blade, cross, self-retaining, 60mm length, for 68-740-002
- 68-510-014 Pilot drill, Ø 1, 0mm, 14mm
- 68-512-014 Pilot drill, Ø 1, 2mm, 14mm
- 68-112-008 Titanium, Ø 1,2mm, 8mm length, cross, 10 pcs.
- 68-115-004 Membrane Screws, selfcutting, 4mm, 10 pcs.

MATCHING ITEMS:**Accesso-**

- 68-720-002 Box for Micro-Screws Ø 1,0/ 1,2/ 1,4mm
- 68-740-002 Screwdriver, 11cm, Fig. 2
- 68-760-106 Blade, cross, self-retaining, short, for Contra-Angle

Pilot Burs:

- 68-510-014 Pilot drill, Ø 1, 0mm, 14mm
- 68-512-014 Pilot drill, Ø 1, 2mm, 14mm
- 68-514-014 Glide Hole drill, Ø 1, 4mm, 14mm

Micro Screws (10 pcs. per Pack):

- 68-112-006 Titanium, Ø 1,2mm, 6mm length, cross, 10 pcs.
- 68-112-008 Titanium, Ø 1,2mm, 8mm length, cross, 10 pcs.
- 68-112-011 Titanium, Ø 1,2mm, 11mm length, cross, 10 pcs.
- 68-112-013 Titanium, Ø 1,2mm, 13mm length, cross, 10 pcs.
- 68-114-006 Titanium, Ø 1,4mm, 6mm length, cross, 10 pcs.
- 68-114-008 Titanium, Ø 1,4mm, 8mm length, cross, 10 pcs.
- 68-114-011 Titanium, Ø 1,4mm, 11mm length, cross, 10 pcs.
- 68-114-013 Titanium, Ø 1,4mm, 13mm length, cross, 10 pcs.
- 68-115-004 Membrane Screws, selfcutting, 4mm, 10 pcs.

68-780-010

Bone-Fixation-Set, Steel,
1,0mm \varnothing

**CONTENTS:**

- 68-720-002 Box for Micro-Screws \varnothing 1,0/ 1,2/ 1,4mm
- 68-740-002 Screwdriver, 11cm, Fig. 2
- 68-508-014 Pilot drill, \varnothing 0, 8mm, 14mm
- 68-110-011 S Steel, \varnothing 1,0mm, 11mm length, cross, 10 pcs.

MATCHING ITEMS:**Accesso-**

- 68-720-002 Box for Micro-Screws \varnothing 1,0/ 1,2/
- 68-740-002 Screwdriver, 11cm, Fig. 2
- 68-760-106 Blade, cross, self-retaining, short, for Contra-Angle

Pilot Burs:

- 68-508-014 Pilot drill, \varnothing 0, 8mm, 14mm
- 68-510-014 Pilot drill, \varnothing 1, 0mm, 14mm

Micro Screws (10 pcs. per Pack):

- 68-110-008 S Steel, \varnothing 1,0mm, 8mm length, cross, 10 pcs.
- 68-110-011 S Steel, \varnothing 1,0mm, 11mm length, cross, 10 pcs.
- 68-110-013 S Steel, \varnothing 1,0mm, 13mm length, cross, 10 pcs.

TITANIUM MICRO SCREWS

- diameter: 1,2 mm / 1,4 mm
- length: 6 mm / 8 mm / 11 mm / 13 mm

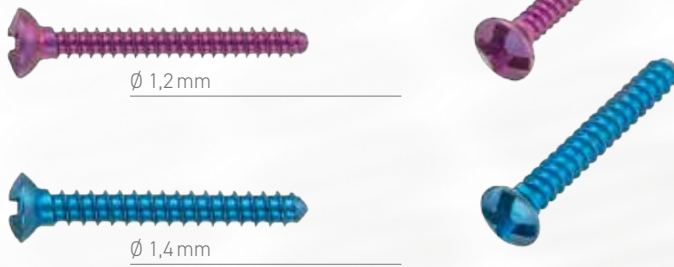

IMPLANT-STEEL ALLOY MICRO SCREWS

- diameter: 1,0 mm
- lengths: 8 mm / 11 mm / 13 mm
- perfectly suited for very small bone grafts and 3D-Augmentations
- special alloy material prevents Osseointegration and therefore a dramatically reduced danger of breaking the screws in comparison to titanium screws of similar lengths

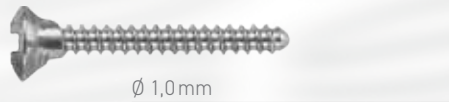

Photo: Jan Kielhorn



Photo: Jan Kielhorn

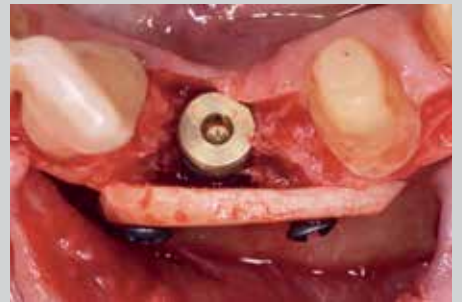

Photo: Dr. Stephan Beuer, M. Sc.



Photo: Dr. Stephan Beuer, M. Sc.



Photo: Dr. Stephan Beuer, M. Sc.



Photo: Dr. Stephan Beuer, M. Sc.

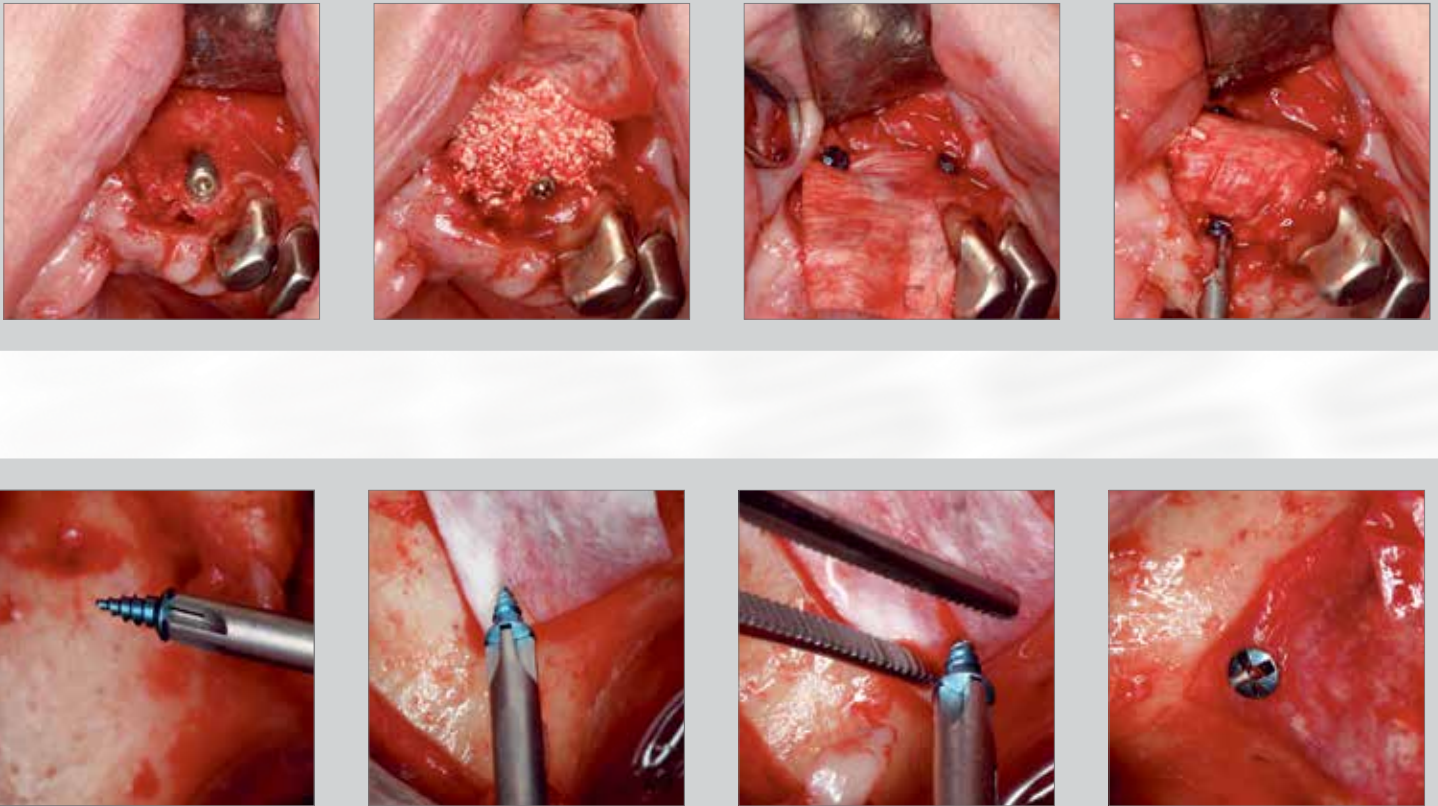

T-FIX MEMBRANE SCREW

- titanium
- conical thread
- length: 4 mm
- self-cutting/self-drilling, no pre-drilling
- perfect for applications in strong cortical bone
- for PTFE and titanium-reinforced membranes



UMBRELLA-TECHNIQUE BY DR. DR. SCHLEE



IMPLANT-STEEL ALLOY

- diameter: 1,2 mm
- lengths: 8 mm / 11 mm / 13 mm
- screw head diameter: 5 mm
- no Osseointegration



highly-magnified presentation

68-780-014

Umbrella-Technique-Set



CONTENT:

- 68-720-010 Box for Umbrella-Screws
- 68-740-002 Screwdriver, 11cm, Fig.
- 68-760-102 Blade, cross, self-retaining, 60mm length, for 68-740-002
- 68-510-014 Pilot drill, Ø 1, 0mm, 14mm
- * 6x Umbrella Screw of choice

Umbrella Screw (packed individually)

- 68-112-208 S Steel, Ø 1, 2mm, 8mm length, cross
- 68-112-211 S Steel, Ø 1, 2mm, 11mm length, cross
- 68-112-213 S Steel, Ø 1, 2mm, 13mm length, cross

Accesso-

- 68-720-002 Box for Micro-Screws Ø 1,0/ 1,2/
- 68-740-002 Screwdriver, 11cm, Fig. 2
- 68-760-106 Blade, cross, self-retaining, short, for Contra-Angle



79 CLEANING AND CARE

INFO

For maintenance of instruments prior to sterilization, for all instruments with joints, scissors, forceps, etc.



79-140-050

SURGI-STAIN, corrosion-ex, Passivation Bath



79-130-040

USTOMED, oil spray, 500 ml, biocompatible, sterilizable

80

EXTRACTING FORCEPS ENGLISH PATTERN





1/1

80-001-000 HP

Figure 1, upper incisors and canines, wide



1/1

80-002-000 HP

Figure 2, upper incisors and canines



1/1

80-334-000 HP

Figure 34, upper incisors and canines, deep-gripping

INFO

Reaches under the gingival margin



80-007-000 HP

Figure 7, upper premolars



INFO
Reaches under the
gingival margin

80-335-000 HP

Figure 35, upper premolars,
deep-gripping

80

English Pattern, non-slip



80-017-000 HP

Figure 17, upper molars,
right



80-018-000 HP

Figure 18, upper molars,
left



80-067-000 HP
Figure 67, upper third molars

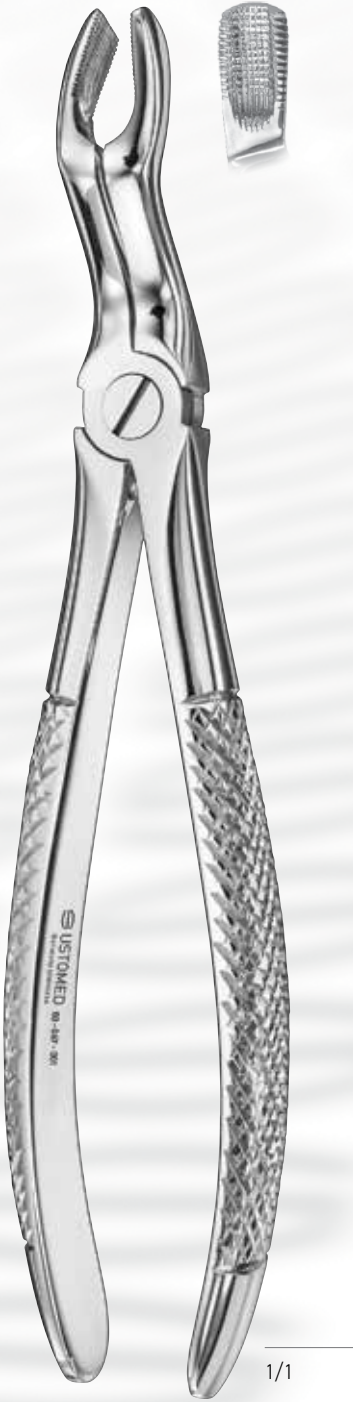

80-067-001 HP
Figure 67A, upper third molars, narrow



1/1

80-051-000 HP

Figure 51, upper roots



1/1

80-051-001 HP

Figure 51A, upper roots,
narrow



1/1

80-051-012 HP

Figure 51L, upper roots,
longer

WITZEL



INFO

The 45° angle allows these forceps to be used for upper and lower roots



80-355-000

1/1

Special Forceps, very fine, upper and lower roots

80-397-000 HP

1/1

Figure 97, upper root fragments

STIEGLITZ



1/1

80-555-000

Special Forceps,
very fine for roots



1/1

17-717-135

Splinter forceps, angled,
diamond-coated

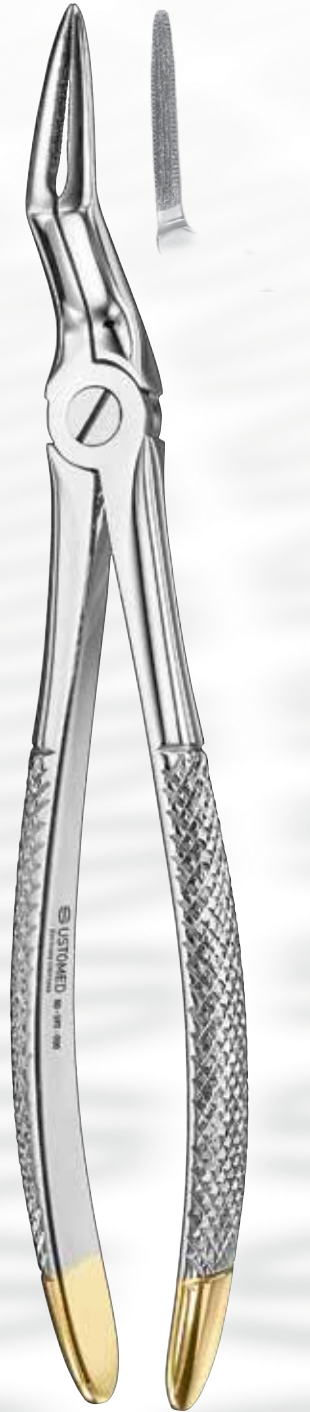

1/1

80-597-000

Figure 97, upper
root fragments



INFO
Reaches under the gingival margin



1/1



1/1



1/1

80-013-000 HP

Figure 13, lower incisors

80-013-001 HP

Figure 13A, premolars, narrow

80-336-000 HP

Figure 36, lower incisors and premolars, deep-gripping

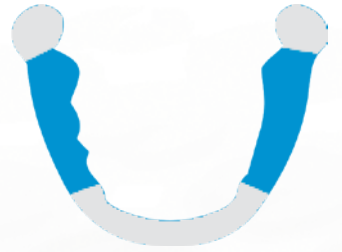

INFO
For children

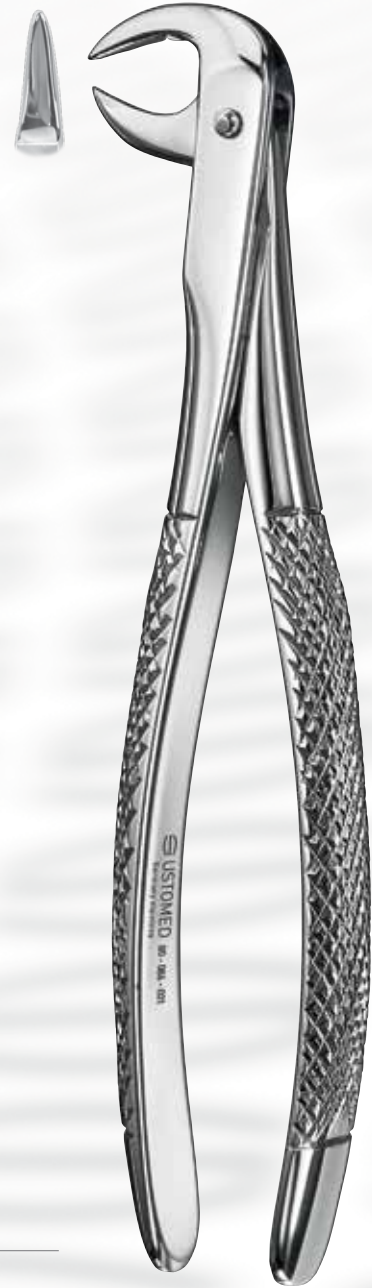

80-022-000 HP

Figure 22, lower molars

80-022-019

Figure 22S, lower molars

80-086-001

Figure 86A, Cowhorn, lower molars

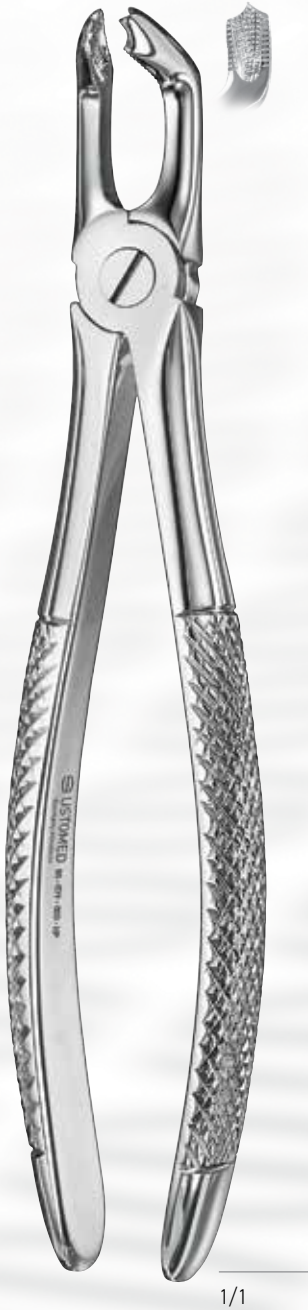
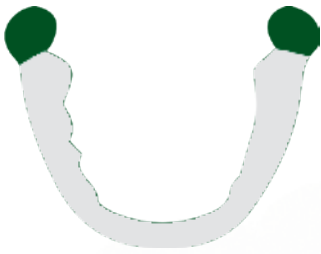

1/1

80-079-000 HP

Figure 79, lower third molars, with tips



1/1

80-079-001 HP

Figure 79A, lower third molars

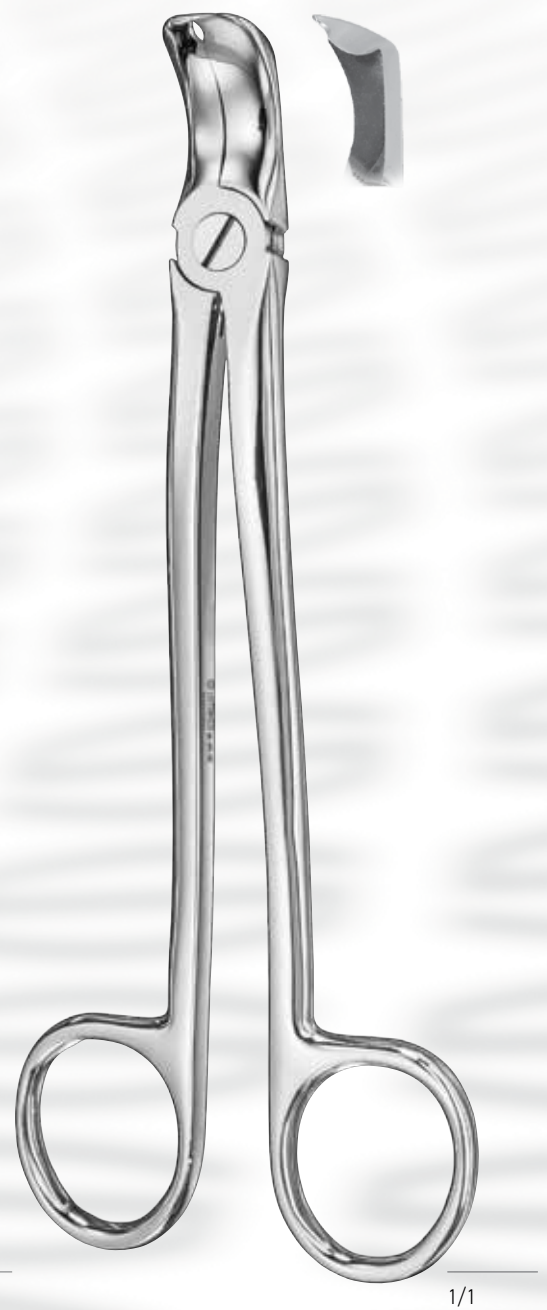

1/1

80-300-000

Special Forceps, upper and lower wisdom teeth

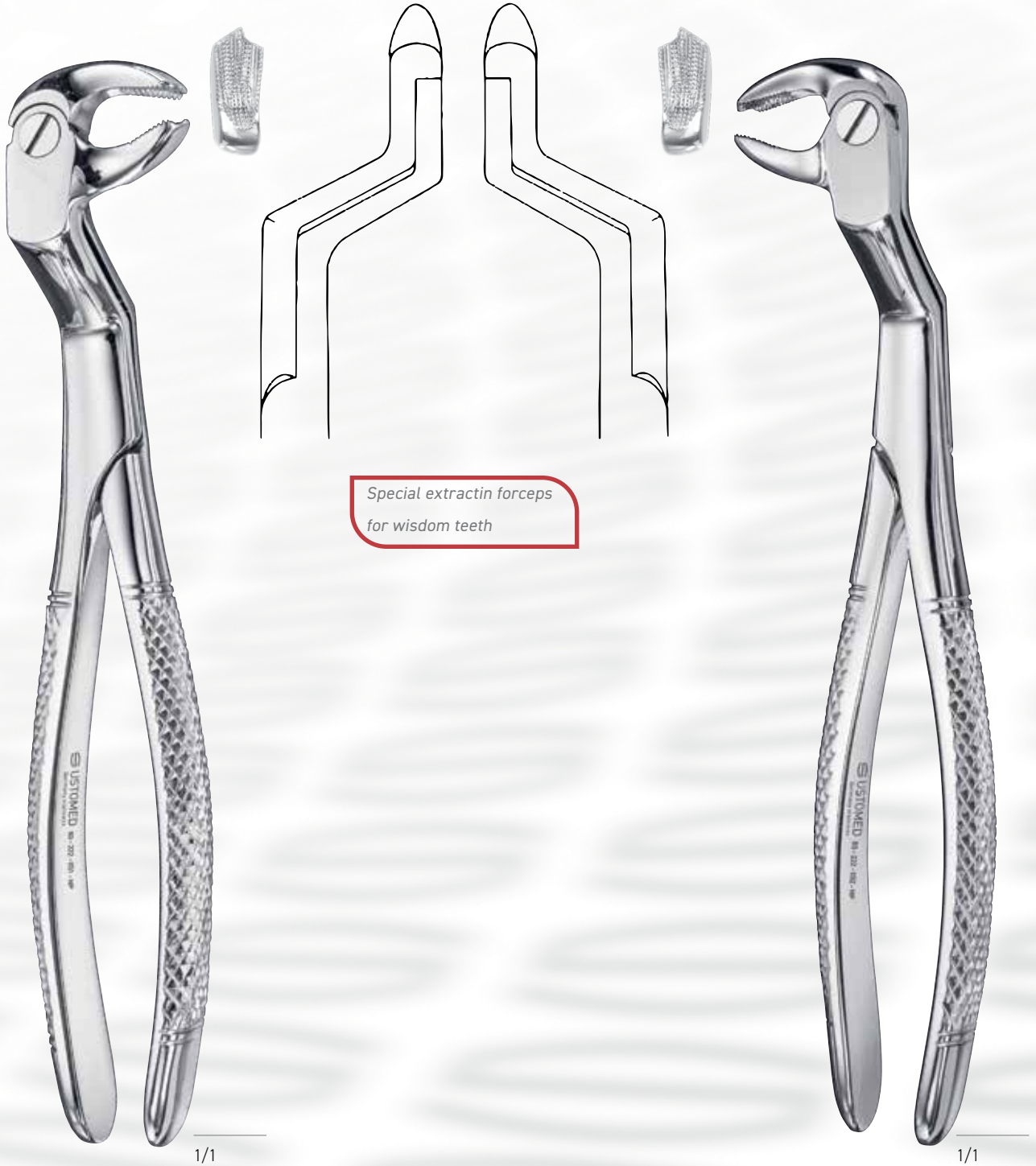
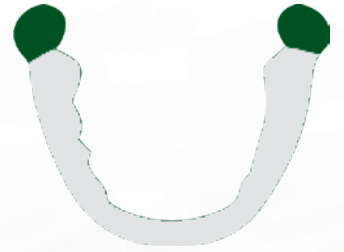

80-222-051 HP

Figure L, lower wisdom teeth,

80-222-052

Figure R, lower wisdom teeth, right

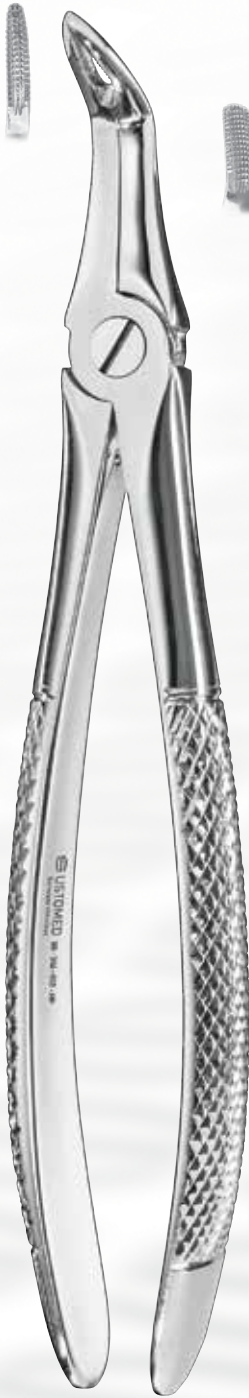

1/1



1/1



1/1



1/1

80-346-012 HP

Figure 46L,
lower roots

80-033-000 HP

Figure 33,
lower roots

80-033-001 HP

Figure 33A, lower
roots, narrow

80-033-012 HP

Figure 33L, lower
roots, longer

STIEGLITZ



1/1

17-717-135

Splinter forceps, angled,
diamond-coated



1/1

80-546-012

Figure 46L,
lower roots



1/1

80-555-000

Special Forceps,
very fine for roots



KLEIN

Extracting Forceps for Children

80



80-860-000
upper incisors

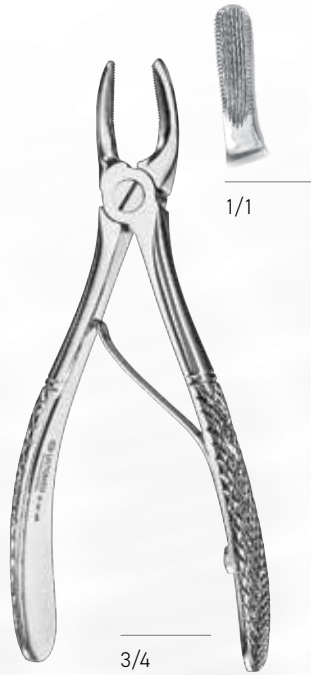

80-861-000
upper premolars



80-865-000
upper molars



80-863-000
upper roots



80-867-000
lower incisors

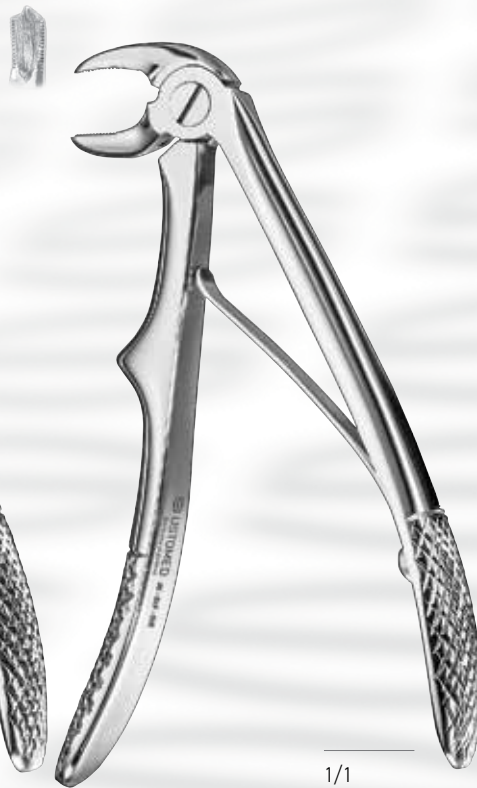

80-869-000
lower molars

80-860-006

complete Set, consisting of 4 forceps upper jaw and 2 forceps lower jaw

80-000-010

Basic Extraction Forceps Set



80-002-000HP
upper Front



80-007-000HP
upper premolars



80-017-000HP
upper molars



80-018-000HP
upper molars



80-067-000HP
upper 3rd molars



80-051-000HP
upper roots



80-013-001HP
lower Front/
premolars



80-022-000HP
lower molars



80-079-001HP
lower 3rd molars



80-346-012HP
lower roots

84

MOUTH MIRRORS



84

Mouth Mirror Handles



1/1



1/1



1/1



1/1



1/1

84-218-000

anatomical shape

84-220-000

solid, round shape

84-225-000P0

peek handle

84-225-000P0T3

peek handle with metal rings

84-224-000

hexagonal shape, stainless-steel

86-080-000

Anatomical USTOMED handle, for probes and mirrors



plane		84-253-004	84-253-005
high-reflection (approx. 20%)		84-265-004	84-265-005
plane, Rhodium (no double pictures)	84-273-003	84-273-004	84-273-005

INFO
User's choice



84-224-004

Combined mirror/
cheek retractor,
plane, Size 4

INFO

In contrast to conventional mirrors, Rhodium front-surface mirrors have the reflecting metal coating applied to the surface of the mirror plate resulting in a **sharply** defined **refraction-free** image.

85

PERIODONTICS



UNIVERSITY NORTH CAROLINA



85-691-015

CP15,
colour marking

85-691-015 P0

CP15, peek handle



85-691-115POT3

CP15 double-ended
with Probe



85-695-012

CP 12, colour
marking

85-695-012P0

CP 12, colour
marking, peek
handle



85-697-000

PSI/WHO,
colour marking

85-697-000P0

PSI/WHO, colour
marking, peek
handle

NABERS

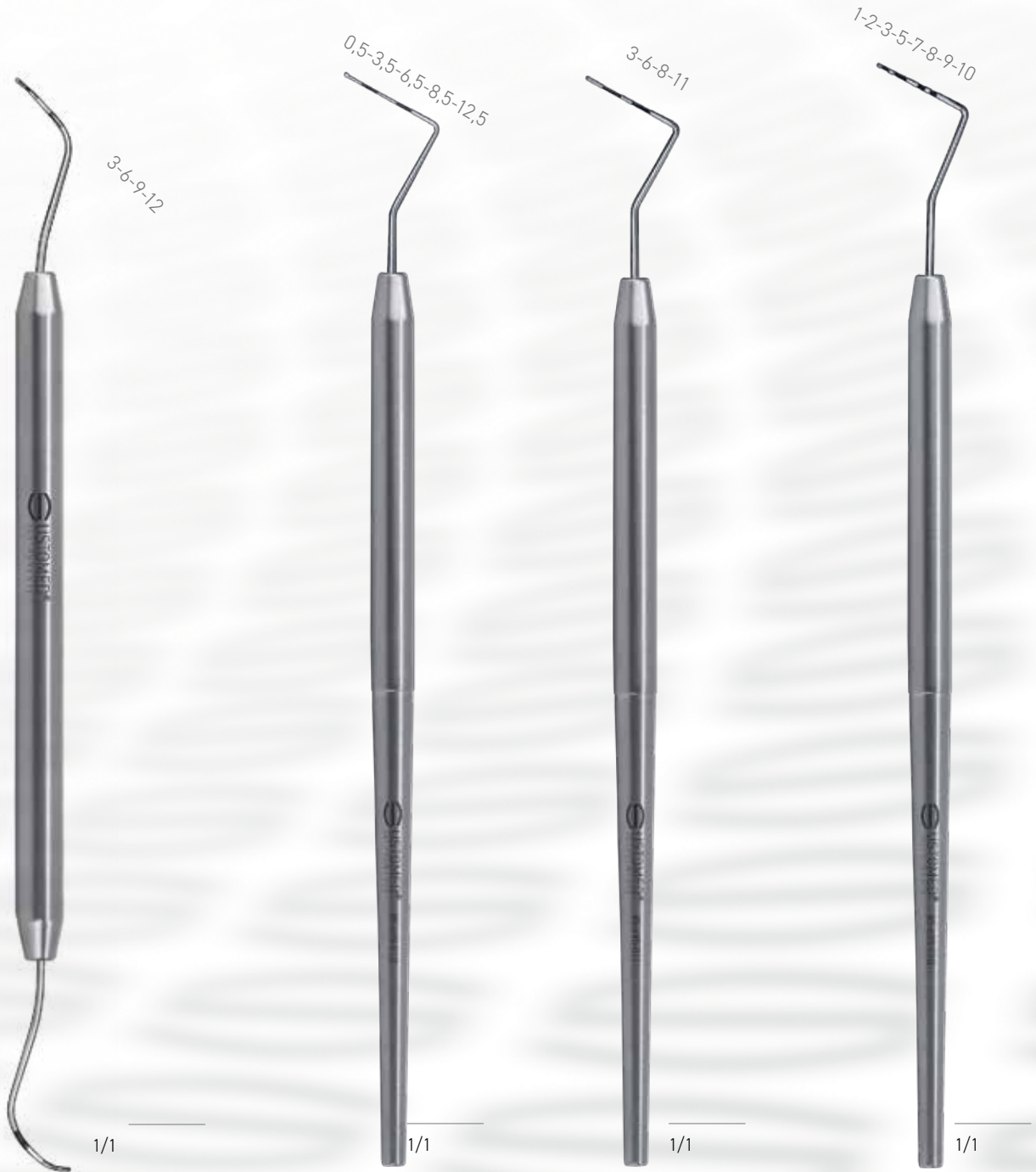

85-691-012

Q2N, probe,
colour marking

85-699-012

CP12 modified,
colour marking,
with tall tip

85-695-011

CP 11, colour
marking

85-693-010

CP 10, colour
marking

GRACEY (ONE SIDED SHARP)



85-781-034
3/4, double-ended

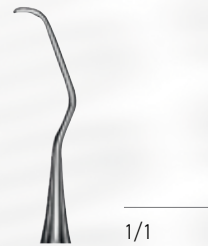

85-781-056
5/6, double-ended

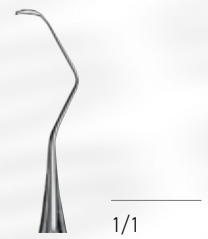

85-781-078
7/8, double-ended

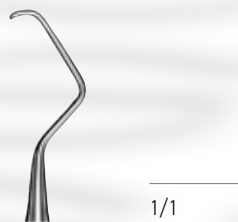

85-781-091
9/10, double-ended

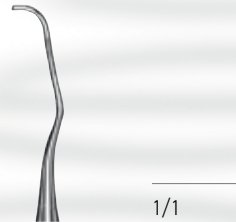

85-781-112
11/12, double-ended



85-781-134
13/14, double-ended

85-781-012
1/2, double-ended

85

Peek Scaler



85-781-056POT3

Curette, 5/6, Peek handle

85-779-056P7T3

Curette, 5/6, Peek,
pink, DLC coat



85-781-078POT2

Curette, 7/8, Peek handle

85-779-078P7T2

Curette, 7/8, Peek,
pink, DLC coat



85-781-112POT4

Curette, 11/12, Peek handle

85-779-112P7T4

Curette, 11/12, Peek,
pink, DLC coat



85-781-134POT1

Curette, 13/14, Peek handle

85-779-134P7T1

Curette, 13/14, Peek,
pink, DLC coat



85-719-067POT6

Scaler, H6/H7,
Peek handle

85-729-204POT5

Scaler, 204 S, Peek
handle

85-729-204PO

Scaler, 204 S, Peek
handle, DLC coating



91-321-006

Perio Set Peek



91-321-005

Perio Set Peek,
pink, DLC coating

85

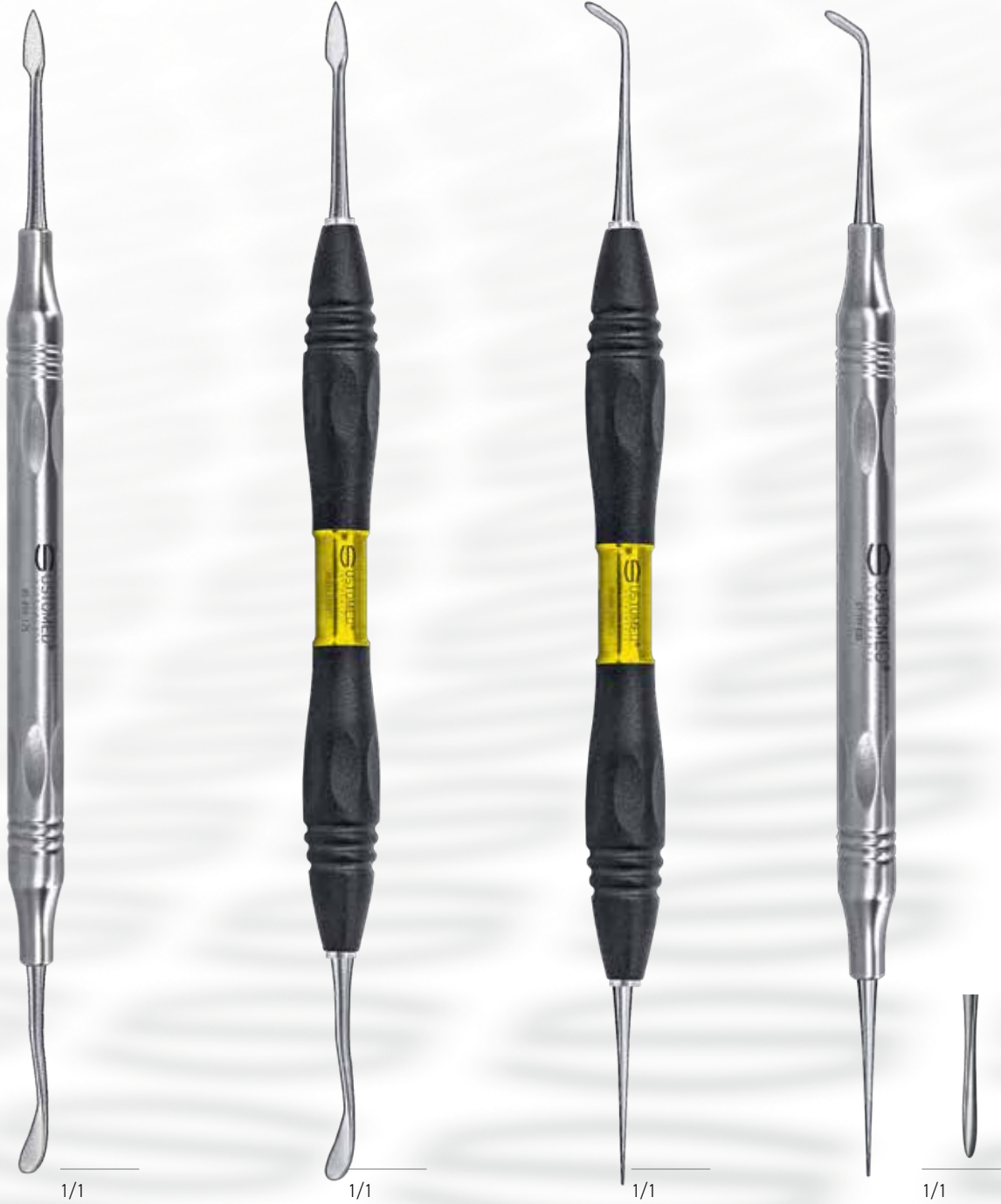

85-816-175

Raspatory Mod. B

85-816-175POT3

Mod. B, 17,5 cm,
peek handle

85-808-175POT3

Mod. W, 17,5 cm,
peek handle

85-808-175

Mod. W, 17,5 cm

KASAJ

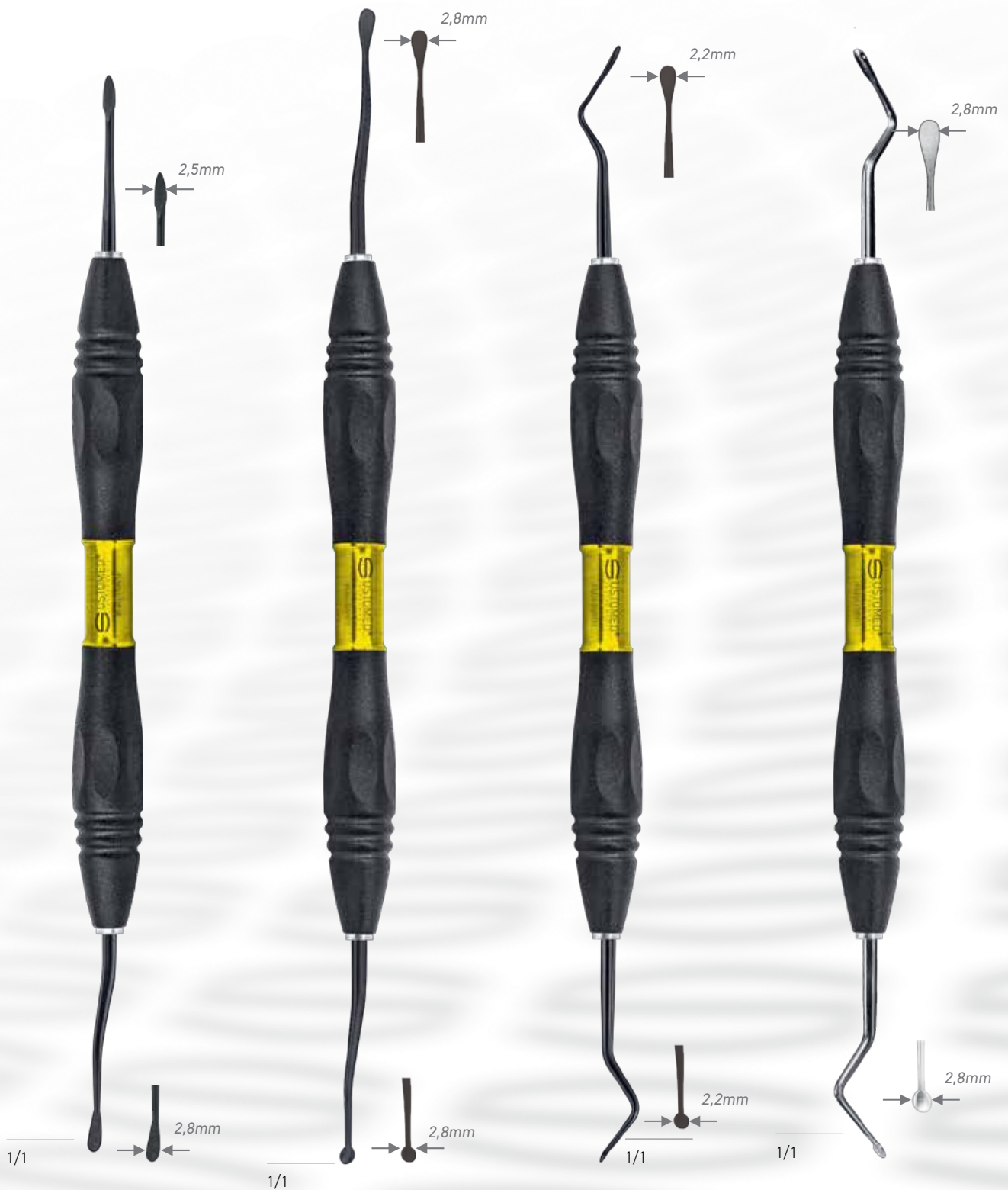

85-816-170 P0T3

Mod. B, micro

85-818-001P0T3

Tunnelling knife,
micro, 20cm,
posterior, peek
handle

85-818-002P0T3

Tunnelling knife,
micro, 19cm,
anterior, peek handle

85-818-175 P0T3

Tunneling knife,
19 cm, anterior,
peek handle

90 STORAGE, ORGANISATION AND STERILIZATION



90-626-040

Sterilization Container,
Full-Size, Pasteurian Loops, 4 cm
315 x 190 x 40mm

90-626-065

Sterilization Container, Full-Size,
Pasteurian Loops, 6,5 cm
315 x 190 x 65mm

90-626-085

Sterilization Container, Full-Size,
Pasteurian Loops, 8,5 cm
315 x 190 x 85mm

90-628-040

Sterilization Container, Demi-Size,
Pasteurian Loops, 4 cm
195 x 145 x 40mm

90-628-065

Sterilization Container, Demi-Size,
Pasteurian Loops, 6,5 cm
195 x 145 x 65mm

**INFO**

Sterilization Container
with permanent filter!



DENTAL STERILIZATION-CONTAINER SYSTEM WITH SAFETY-FILTER

Ustomed's answer to consistently increasing demands for risk minimization, environmental protection and handling comfort, is the newly-developed Easy-Stop System.

The filterless mechanism stops microorganisms even more effectively than conventional filter systems and can be re-used as often as you like. There is no need for consumable purchasing.

To open or close, one handling step is enough:

Simply, press the lid down, and turn!

THE ADVANTAGES SPEAK FOR THEMSELVES:

- The unique lid is almost indestructible:
It is precision-milled from a solid block of aluminum. That way, the lid stays in shape and can withstand the daily office routines.
- Dirt- and germ-repellent
- Fast and residue-free drying during steam-sterilization
- High quality material for triple safety: adhere-free, pore-free and corrosion-free

INFO:

The two-piece aluminum insert in the lid serves as a germ barrier according to the principle of the „Pasteur Loops“. By forming a labyrinth of ring ribs, it therefore reliably separates microbes, germs and particles.

The meandering flow path achieves a decontamination rate of 99.997%



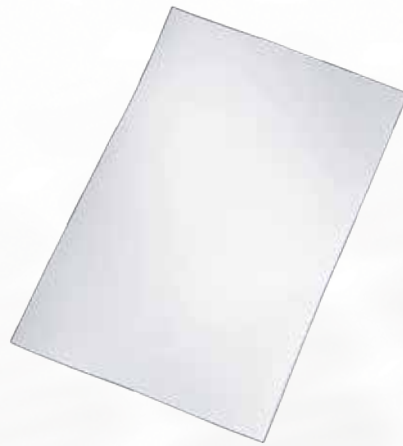

Ustomed Teflon-Filter

90-643-001

Teflon-Filter, for series
90-620-xxx

90-642-001

Teflon-Filter, for series
90-618-xxx

Marking Plates, including labeling

(max. 16 characters)



90-650-000

Red



90-650-001

Blue



90-650-002

Green



90-650-003

Yellow



90-650-004

Black



90-650-005

Silver



90-650-007

Purple



90-650-008

Orange



90-665-100

Sealing Plombs with
indicator fields (100 pcs/
pack)

or

90-665-101

Sealing Plombs
(1000 pcs/pack)



90-654-000

Identification Label,
HIBC, Data Matrix

or

90-656-000

Identification Label,
HIBC, Code 128



90-655-000

Plate for Stickers



90-662-100

Indicator Labels
(100 pcs/pack)

INSTRUMENT SETS 91

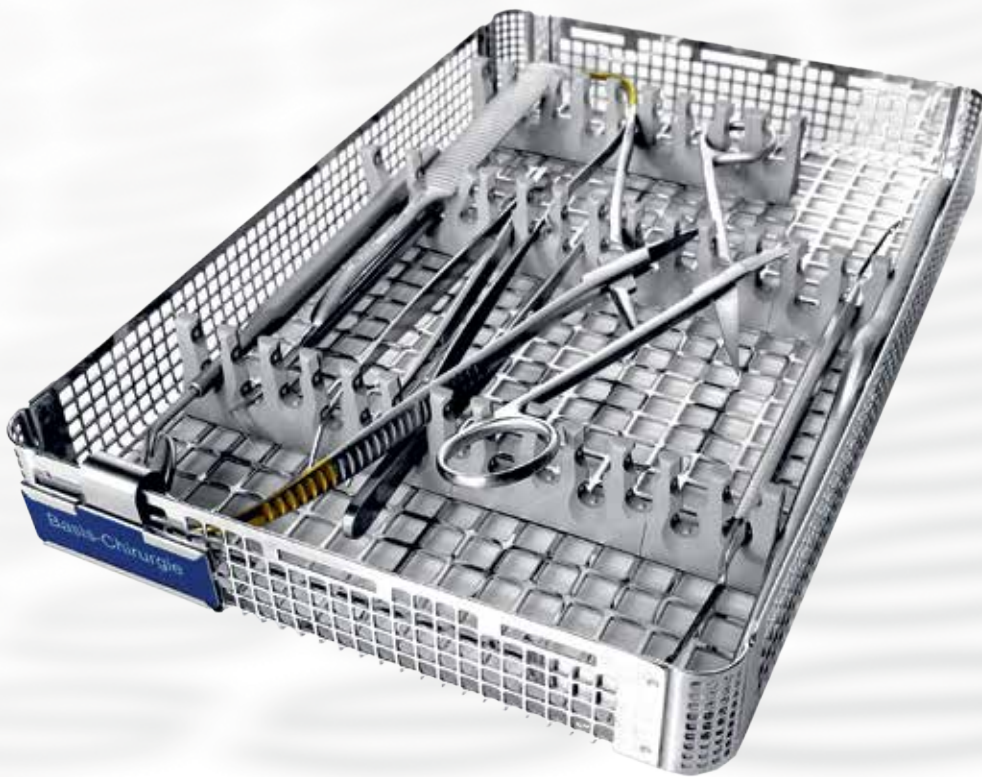

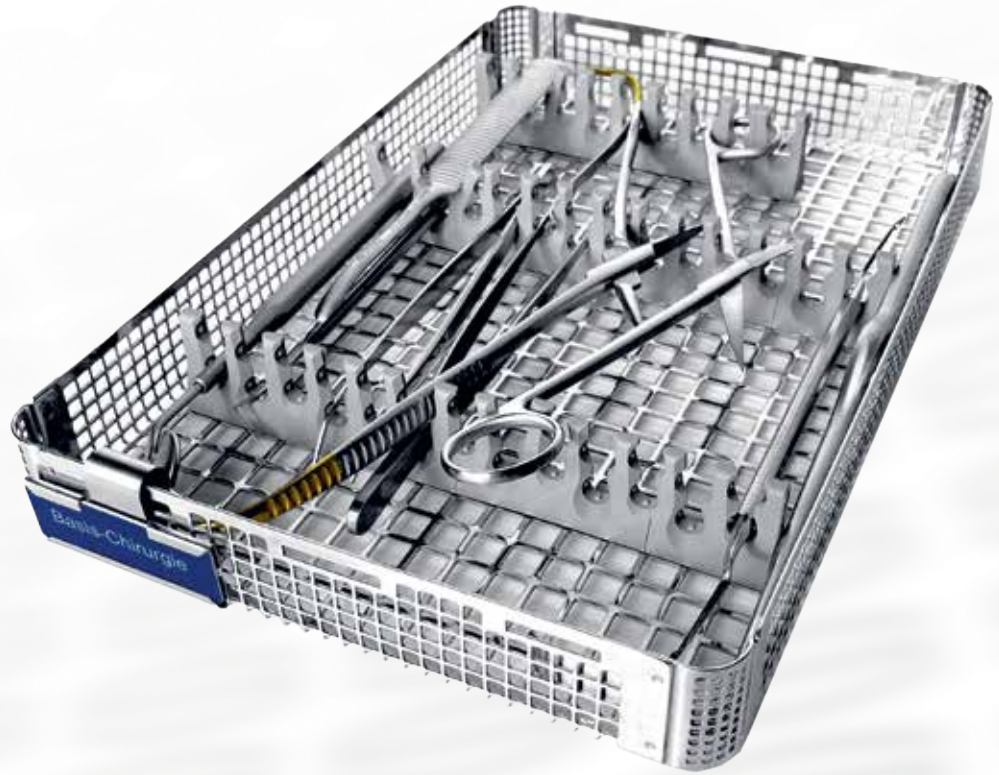

91-100-001

Basic Surgical Set

Constituent Parts:

02-030-030	Scalpel handle, No. 3
03-441-140	JOSEPH, suture-/gum scissors, 14 cm, cvd.
08-235-160	Tissue forceps, 16cm, str., 1x2 t., v.delic.
10-801-150	COLLEGE, tweezers, 15 cm, serrated jaws
20-470-170	LICHTENBERG, needle holder, 17 cm
24-169-005	LANGENBECK, retractor, size 5, 50 x 11mm
27-717-175	Periosteal elevator, 17, 5 cm, d. e., cvd.
27-741-160	WILLIGER, periosteal elevator, 16 cm, cvd.
67-799-020	HEMINGWAY, bone curette, 18 cm, d/e., size 2
84-224-000	Mouth mirror handle, hexagonal, s.s.
86-153-001	Probe, size 1, single-ended, round handle
90-716-001	Wash Basket, Full-Size, MK 3, cross-wise racks

SET 91



02-030-030



03-441-140



08-235-160



10-801-150



20-470-170



24-169-005



27-717-175



27-741-160



67-799-020



84-224-000



86-153-001



90-716-001



91-100-003

Micro Set Basic

Constituent Parts:

02-038-140	Micro-Scalpel Handle, 14 cm, anatomical shape
05-809-180	Micro-spring handle scrs., 18cm, cvd.round
09-270-180	DE BAKEY, micro atraum. fcps., 18cm, str.
20-710-180	BARRAQUER, TC Micro-Needle Holder, 18 cm, straight, round handle
85-691-015	UNIV.NORTH CAROLINA, period. probe CP15
85-816-170 P0T3	USTOMED, Mod. B, micro raspatory, 17cm
85-818-002 P0T3	KASAJ, tunnelling knife, Micro, 19cm, cvd.
90-716-001	Wash Basket, Full-Size, MK 4, cross-wise racks



02-038-140



05-809-180



09-270-180



20-710-180



85-691-015



85-816-170P0T3



85-818-002P0T3



90-716-001



„I am using the I'Motion set for about a year. It is working perfectly with 6/0-7/0 threads. Thanks to it's small head and precise lock, I can work with it gently, furthermore, it is extremely rare to tear the thread, owing to it's rounded, smooth shape. It fits easily into narrow places.

PERFECT CHOICE

NOT ONLY FOR PERIODONTAL PLASTIC MICRO-SURGERIES!

Dr. Dávid Botond Hangyási



I appreciate the ergonomic and lightweight design of these instruments providing a precise and

CONTROLLED HANDLING

EVEN DURING LONG SURGERIES.

Prof. Dr. Adrian Kasaj, DDS, MSc, PhD

91-180-000

Mucogingival Plastic Surgery Set

05-803-180	I'Motion, Micro-scissors, 18cm, cvd
09-280-180	I'Motion, Micro-forceps, Cooley,
20-753-180	I'Motion, Micro-Needleholder, 18cm, curved, TC Alternativ 20-752-180
02-038-140	Micro-Scalpel Handle, 14 cm, anatomical shape
10-871-160	Suture forceps, 16 cm, with eye tips
85-691-115 P0T3	UNIV.NORTH CAROLINA, period. probe CP15+Probe
85-814-175 P0T3	Papilla elevator, 17, 5cm, Mod. Z
85-818-001 P0T3	KASAJ, tunnelling knife, 20cm, straight
85-818-002 P0T3	KASAJ, tunnelling knife, Micro, 19cm, cvd.
85-818-175 P0T3	Tunneling knife, 19 cm, cvd.
90-716-001	Wash Basket, Full-Size, MK 2, Flexi-Kit



ULTRA-LIGHT
MICRO INSTRUMENTS

THE NEW BENCHMARK IN SURGERY



02-038-140



05-803-180



09-280-180



10-871-160



20-753-180
OR
20-752-180



85-691-115POT3



85-814-175POT3



85-818-001POT3



85-818-002POT3



85-818-175POT3



90-716-001



Vitsaropoulos
COMPLETE DENTAL SOLUTIONS

Μεσογείων 348, 153 41 Αγ. Παρασκευή • T: 210 65 41 340 F: 210 65 41 618
info@vitsaropoulos.gr • vitsaropoulos.gr • facebook.com/vitsaropoulos